

EWRC 300/500 NT

Controllers for cold rooms for on-board installation



**USER
MANUAL**



1. INTRODUCTION	5
1.1. GENERAL DESCRIPTION	5
1.2. ADVANTAGES AND FEATURES	5
1.3. MODELS	5
2. TECHNICAL DATA	6
2.1. TECHNICAL SPECIFICATIONS (EN 60730-2-9)	6
2.2. FURTHER INFORMATION	6
2.2.1. INPUT CHARACTERISTICS	6
2.2.2. OUTPUT CHARACTERISTICS	7
2.2.3. MECHANICAL CHARACTERISTICS	7
2.2.4. FOOD SAFETY	7
2.3. DISPOSAL	7
3. CONNECTIONS.....	8
3.1. GENERAL WARNINGS	8
3.1.1. POWER SUPPLY - DANGEROUS VOLTAGE OUTPUTS (RELAY).....	8
3.1.2. ANALOGUE INPUTS-PROBES.....	8
3.1.3. SERIAL CONNECTIONS	8
3.1.4. RS485 CONNECTION	8
3.1.5. TTL CONNECTION	8
3.2. WIRING DIAGRAM	9
3.2.1. TERMINALS	9
4. MECHANICAL INSTALLATION	10
4.1. MECHANICAL INSTALLATION.....	10
4.1.1. WALL-MOUNTING	10
5. USER AND START-UP INTERFACE	13
5.1. DISPLAY	13
5.1.1. KEYS.....	13
5.1.2. LEDS.....	14
5.1.3. PRELIMINARY CONFIGURATIONS.....	15
5.1.4. OPERATION IN DEFAULT CONFIGURATION	15
5.1.5. NAVIGATION	16
5.1.6. FUNCTIONS MENU AND KEY-ACTIVATED FUNCTIONS.....	17
5.1.7. PASSWORD	18
5.1.8. SETTING THE SETPOINT	19
5.1.9. VIEWING PROBE VALUES	20
5.1.10. HOW TO MODIFY THE DATE AND TIME	21
5.1.11. DISPLAYING ALARMS	22
5.1.12. SYSTEM ALARMS EXAMPLE	22
5.1.13. MODIFYING A PARAMETER	23
5.1.13.1 How to modify a user parameter	23
5.1.13.2 How to modify an Installer parameter	24



6. FUNCTIONS AND REGULATORS.....	25
6.1. SETTINGS	25
6.1.1. PROBE SETTING AND CALIBRATION	25
6.1.2. DISPLAY SETTINGS	25
6.2. FUNCTIONS	26
6.2.1. UPLOAD, DOWNLOAD, FORMAT	26
6.2.2. MULTI FUNCTION KEY	27
6.2.3. UNICARD.....	27
6.3. BOOT LOADER FIRMWARE.....	28
6.4. COMPRESSOR	29
6.4.1. COMPRESSOR CONFIGURATION	29
6.4.2. SECOND COMPRESSOR CONFIGURATION.....	29
6.4.3. COMPRESSOR OPERATING CONDITIONS.....	29
6.5. COMPRESSOR/GENERAL PROTECTIONS.....	30
6.5.1. COMPRESSOR SAFETY TIMINGS.....	31
6.6. DEFROST/DRIPPING	32
6.6.1. DEFROST TYPE AND ACTIVATION	32
6.6.2. AUTOMATIC DEFROSTING	33
6.6.3. MANUAL DEFROST.....	33
6.6.4. EXTERNAL DEFROST.....	34
6.7. DEFROST MODE	35
6.7.1. DEFROST WITH ELECTRIC HEATERS	35
6.7.2. INVERSE DEFROST.....	36
6.7.3. DOUBLE EVAPORATOR DEFROST	37
6.8. EVAPORATOR FANS.....	39
6.8.1. EVAPORATOR FAN OPERATING CONDITIONS	39
6.8.2. FAN OPERATION IN THERMOREGULATION MODE.....	40
6.8.3. FAN OPERATION IN DUTY CYCLE MODE.....	40
6.8.4. FAN OPERATION IN DEFROST.....	41
6.8.4.1 Fan operation without probe	41
6.8.5. FAN FUNCTION DURING DRIPPING	42
6.8.6. POST-VENTILATION.....	42
6.9. DEEP COOLING CYCLE - DCC	43
6.10. PREHEAT.....	43
6.11. PRESSURE SWITCH	44
6.11.1. AUXILIARY OUTPUT (AUX/LIGHT).....	45
6.12. DOOR/EXTERNAL ALARM MANAGEMENT	46
6.13. DEMISTING HEATERS (FRAME HEATERS).....	48
6.14. CONDENSER FANS	49
6.15. STAND-BY	50
6.16. PUMP DOWN.....	50
6.16.1. SERVICE STOPPAGE	50



7. PARAMETERS	51
7.1. HOW TO MODIFY THE USER PARAMETERS	51
7.2. HOW TO EDIT THE INSTALLER LEVEL PARAMETERS	51
7.3. PARAMETER TABLE	52
7.3.1. PARAMETER H60	61
8. ALARMS	62
8.1. ALARMS AND SIGNALS TABLE	62
8.2. ALARM CAUSE/EFFECT TABLE	63
8.3. DESCRIPTION OF ALARMS	65
8.3.1. PROBE ALARM	65
8.3.2. MINIMUM AND MAXIMUM TEMPERATURE ALARM	66
8.3.3. END OF DEFROST DUE TO TIMEOUT ALARM	67
8.3.4. EXTERNAL ALARM	67
8.3.5. DOOR OPEN ALARM	68
8.3.6. PRESSURE SWITCH INPUT ALARM	69
8.3.7. PANIC ALARM	69
9. MODBUS MSK 554 FUNCTIONS AND RESOURCES	70
9.3.1. DATA FORMAT (RTU)	70
9.3.2. NETWORK	70
9.3.3. MODBUS COMMANDS AVAILBLE AND DATA AREAS	71
9.3.4. ADDRESS CONFIGURATION	71
9.3.5. PARAMETER VISIBILITY AND VALUES	72
9.3.6. MODBUS TABLES	72
9.3.7. PARAMETER/VISIBILITY TABLE	74
9.3.8. PARAMETER/VISIBILITY H60 TABLE	78
9.3.9. FOLDER VISIBILITY TABLE	80
9.3.10. CLIENT TABLE	80
10. ADVANCED FUNCTIONS - NIGHT AND DAY	82
10.1. DAY/NIGHT REGULATOR OPERATION	82
10.2. OPERATION WITH DEFROST GROUP	83
10.3. DAY/NIGHT REGULATOR DURING A BLACKOUT	83
10.4. OPENING FOLDER NAD - DAY/NIGHT	84
11. ADVANCED FUNCTIONS - HACCP	85
11.1. DISPLAYING HACCP ALARMS	86



1. INTRODUCTION

1.1. GENERAL DESCRIPTION

Using a single device, controllers in the new **Coldface NT** series are able to manage all the functions of a static or ventilated cold room.

With its innovative design, the casing combines ease of installation, water resistance and the possibility of installing a power contactor or a magnetothermal switch. Controllers in the **Coldface NT** series are easy and intuitive to use thanks to the high-visibility double display, the light-up icons and the four large keys for direct access to the functions. The controllers are available with a series of advanced functions, such as the recording of HACCP events with a yearly calendar.

1.2. ADVANTAGES AND FEATURES

- Complete management of a static or ventilated cold room
- Innovative design for easy installation and use
- Intuitive navigation with most frequently used parameters
- Large high-visibility display
- Facility for housing accessories on DIN rail

1.3. MODELS

Controllers in the new Coldface series allow you to control the temperature of a static or ventilated cold room with single-phase compressors up to 2HP.

They are suited to the control of commercial and industrial cold rooms and, thanks to the wide range of outputs available,

provide control of all associated functions, including lights, alarms, and condensation fans.

The products are equipped with an optional RS-485 serial port, which enables connection to TelevisSystem and ModBUS without the need for external accessories.

The controllers offer simple and intuitive operation: the LED double display, with 6 navigation keys, ensures the clear and simultaneous display of all active functions.

The HACCP function sets, maintains and memorises temperature measurements and any associated alarms, ensuring the quality and hygiene of stored products.

- EWRC 300 NT - Versions with 3 configurable relays for controlling all the accessory loads in the room.
- EWRC 500 NT - Versions with 5 configurable relays for controlling all the accessory loads in the room.

2. TECHNICAL DATA



2.1. TECHNICAL SPECIFICATIONS (EN 60730-2-9)

Front panel protection rating	IP65
Classification:	electronic automatic control (not safety) device for stand-alone installation
Mounting:	wall-mounted (hole spacing A-B 116 mm; C-D 87 mm; A-C 235 mm)
Type of action:	1.B
Pollution class:	2
Material class:	IIIa
Over-voltage category:	II
Nominal pulse voltage:	2500V
Operating temperature:	-5 ... +50°C
Storage temperature:	-20 ... +85°C
Operating humidity:	10 ... 90%
Storage humidity:	10 ... 90%
Power supply:	230V~ ±10% 50/60 Hz
Power consumption:	14W max
Connection:	device on external flexible cable, Y type connection
Digital outputs (relay):	refer to the label on the device
Fire resistance category:	D
Software class:	A
Ball test temperature:	100°C
RTC battery life:	Without any external power supply, the clock battery will last 4 days.

2.2. FURTHER INFORMATION

2.2.1. INPUT CHARACTERISTICS

Measurement range:	NTC: -50.0°C ... +110°C; (on 3-digit display with +/- sign) PTC: -55.0°C ... +150°C; (on 3-digit display with +/- sign)
Accuracy:	0.5% f.s + 1 digit
Resolution:	0.1 °C
Buzzer:	YES
Analogue Inputs:	3 configurable NTC/PTC inputs
Digital Inputs:	2 multi-function, voltage-free digital inputs (DI)

	NTC	PTC
Measurement range	-50.0...+110°C -58...302°F	-55.0...+150°C -67...302°F
Resolution	0.1°C 0.1°F	0.1°C 0.1°F
F.S. precision	0.5% f.s. + 1 digit	0.5% f.s. + 1 digit
Impedance	-	-
* probes not included - contact the Eliwell Sales Office for accessories		



2.2.2. OUTPUT CHARACTERISTICS

Digital Outputs:	OUT1 common-line output	2HP 12(12)A 250V~
	OUT2 common-line output	1HP 8(8)A 250V~
	OUT3 common-line output	1/2HP 8(4)A 250V~
EWRC500 NT model only	OUT4 common-line output	1HP 8(8)A 250V~
EWRC500 NT model only	OUT5 SPDT output	1/2HP 8(4)A 250V~
	Common-line max 18A	

2.2.3. MECHANICAL CHARACTERISTICS

Casing:	Bayblend FR 3010
Dimensions:	front panel 213x318mm, depth 102mm
Terminals:	screw <ul style="list-style-type: none">• Probe and digital inputs, OUT5 relay: screw-on terminals pitch 5.01: electric cables of 2.5 mm² maximum cross-section (one wire per terminal in the case of power connections).• Power supply and OUT1..OUT4 relays: screw-on terminals pitch 7.62: electric cables of 4 mm² maximum cross-section (one wire per terminal in the case of power connections).
Connectors:	TTL for Unicard / MFK / CopyCard / Device Manager connection (via DMI)
Humidity:	Operation / Storage: 10...90% RH (non-condensing)

2.2.4. FOOD SAFETY

The device conforms to Standard EN13485 as follows:

- Suitable for storage.
 - Application: air.
 - Climate range A.
 - Measurement class 1 in the -25°C to 15°C range (*).
- (* exclusively using Eliwell probes)

NOTE: The technical specifications stated in this document regarding measurement (range, accuracy, resolution, etc.) refer to the instrument alone and not to any accessories provided, such as the probes. This means, for example, that the error introduced by the probe must be added to the characteristic error of the instrument.

2.3. DISPOSAL



The equipment (or product) must be subjected to separate waste collection in compliance with the local legislation on waste disposal.

3. CONNECTIONS



3.1. GENERAL WARNINGS

IMPORTANT!

Make sure the appliance is switched off before working on the electrical connections.

All operations must be carried out by qualified personnel.

To ensure proper connections, comply with the following:

- Power supplies other than those specified can seriously damage the system.
- Use cables of suitable cross-section for the terminals
- The device is equipped with screw terminals (a single conductor per terminal for the power feeding connections): refer to the label on the instrument for details of the terminal ratings.
- When current exceeds 8A on relay outputs, 2 x 2.5mm² cables must be run out for each individual contact to ensure the temperature of the cables does not exceed 85°C.
- Separate the cables of probes and digital inputs from inductive loads and dangerous voltage connections to prevent any electromagnetic interference. Do not place the probe cables near other electrical equipment (switches, meters, etc.)
- Make connections as short as possible and do not wind them around electrically connected parts.
- To avoid causing static discharges, do not touch the electronic components on the boards.

3.1.1. POWER SUPPLY - DANGEROUS VOLTAGE OUTPUTS (RELAY)

Do not exceed the maximum permitted current; for higher loads, use a contactor with sufficient power capacity.

Important!

Make sure that power supply is of the correct voltage for the instrument.

3.1.2. ANALOGUE INPUTS-PROBES

Temperature probes have no connection polarity and can be extended using a normal bipolar cable (note that the extension of the probes influences the instrument's EMC electromagnetic compatibility and measurement class: take great care with the wiring).

3.1.3. SERIAL CONNECTIONS

The controller can be connected to Televis**System** remote control systems by a direct RS-485 connection using the RS485 optional plug-in module.

3.1.4. RS485 CONNECTION

Use a shielded and "twisted" cable with two 0.5mm² conductors, plus braiding (i.e. Belden cable model 8762 with PVC sleeve, 2 conductors plus braiding, 20 AWG, nominal capacity between conductors 89pF, nominal capacity of 161pF between conductor and shielding).

See standards relating to EN 50174 data transmission systems for indications on how to lay cables.

Extra care must be taken in separating data transmission circuits from power lines.

An RS-485 network up to 1200m in length featuring a maximum of 32 devices can be connected straight to the controller.

This length can be extended and the number of devices for each channel increased using appropriate repeater modules.

Attach the 120Ω 1/4W resistors between the "+" and "-" terminals on the interface and the last controller in each branch of the network.

3.1.5. TTL CONNECTION

Use a 5-wire TTL cable up to 3 m in length.

An Eliwell-supplied TTL cable is recommended. Contact Eliwell Sales Office for item availability.



3.2. WIRING DIAGRAM

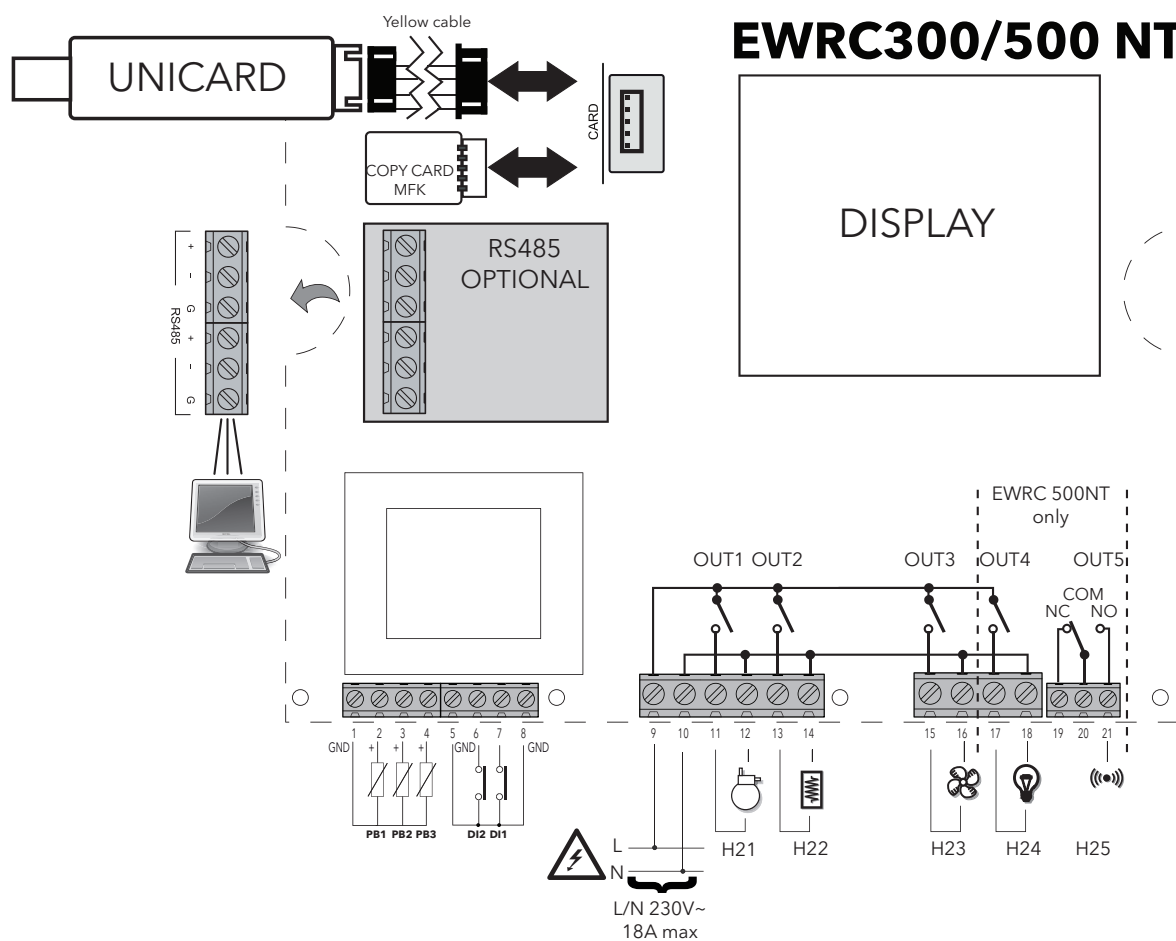

3.2.1. TERMINALS

TERMINALS	
1, 5, 8	GND
2	Analogue input Pb1
3	Analogue input Pb2
4	Analogue input Pb3
6	Digital input DI2
7	Digital input DI1
CARD	TTL for connection to UNICARD / CopyCard
RS485	Plugin module for connection to TelevisSystem (optional)
9, 10	LINE/NEUTRAL. Power supply
11	N.O. OUT1
12	NEUTRAL
13	N.O. OUT2
14	NEUTRAL
15	N.O. OUT3
16	NEUTRAL
17	N.O. OUT4
18	NEUTRAL
19	N.C. OUT5
20	OUT5 Common terminal
21	N.O. OUT5

4. MECHANICAL INSTALLATION



4.1. MECHANICAL INSTALLATION

Do not install the device in damp and/or dirty areas; it is intended for use in sites with ordinary or normal levels of pollution. Keep the area around the instrument cooling slots adequately ventilated.

4.1.1. WALL-MOUNTING

1. Remove the screws (self-tapping 3.5x32 TC head) securing the cap at the top and then open the cover.
2. Drill holes for the high and low voltage cable glands on the sides of the backplate, as shown in the figure. Check that the cables are inside the box. Use suitable cable glands and/or conduit glands that guarantee an airtight seal for all wiring
3. Drill 4 holes (see A...D) in the wall and fix the backplate in place using 4 screws (not supplied) suited to the wall thickness.
4. Insert plug covers TDI 20 (accessory available on request).
5. Close the door and re-tighten the 4 cover screws, making sure that the hinges are flush and do not interfere with the closure of the cover.

Hinges are available for mounting on special compartments for opening the cover both right and left.

Screw on the respective anchoring screws taking care that the hinges are fitted well and lie flush so that they do not interfere with the compression of the seal

Option of installing

- magnetothermal switch
- contactor
- remote switch
- etc.

In versions which include a door and magnetothermal switch, the latter is supplied installed on a DIN rail, which is fixed to the plastic backplate using 2 screws.

The installer must wire the magnetothermal switch to the electronics board using the 2 wires provided with the package as an accessory.

Other DIN modules can be installed on the lower part of the cover. Two barriers are fitted; these can be removed easily using a tool or your fingers.

NOTE: Do not install the BusAdapter inside the Coldface EWRC300/500 NT

Removing barriers for DIN module installation

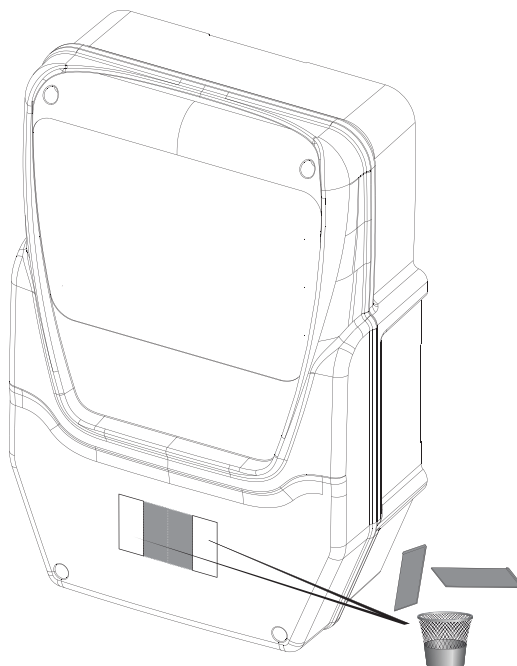



Removing the cover

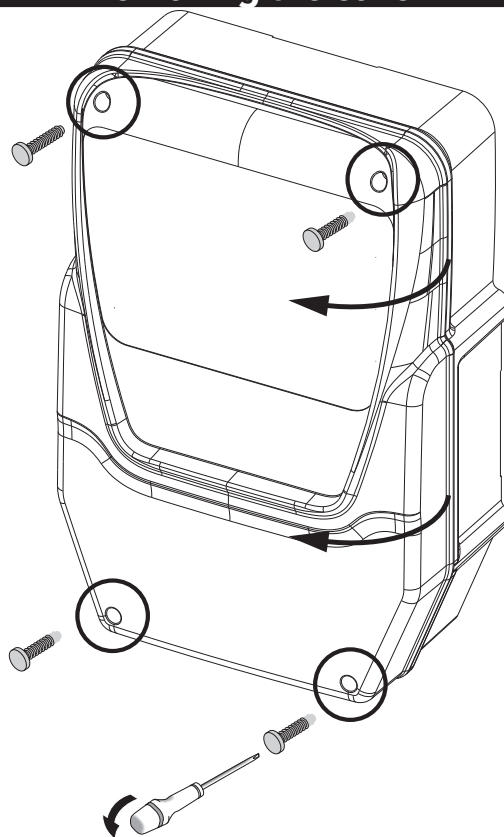

Wall installation

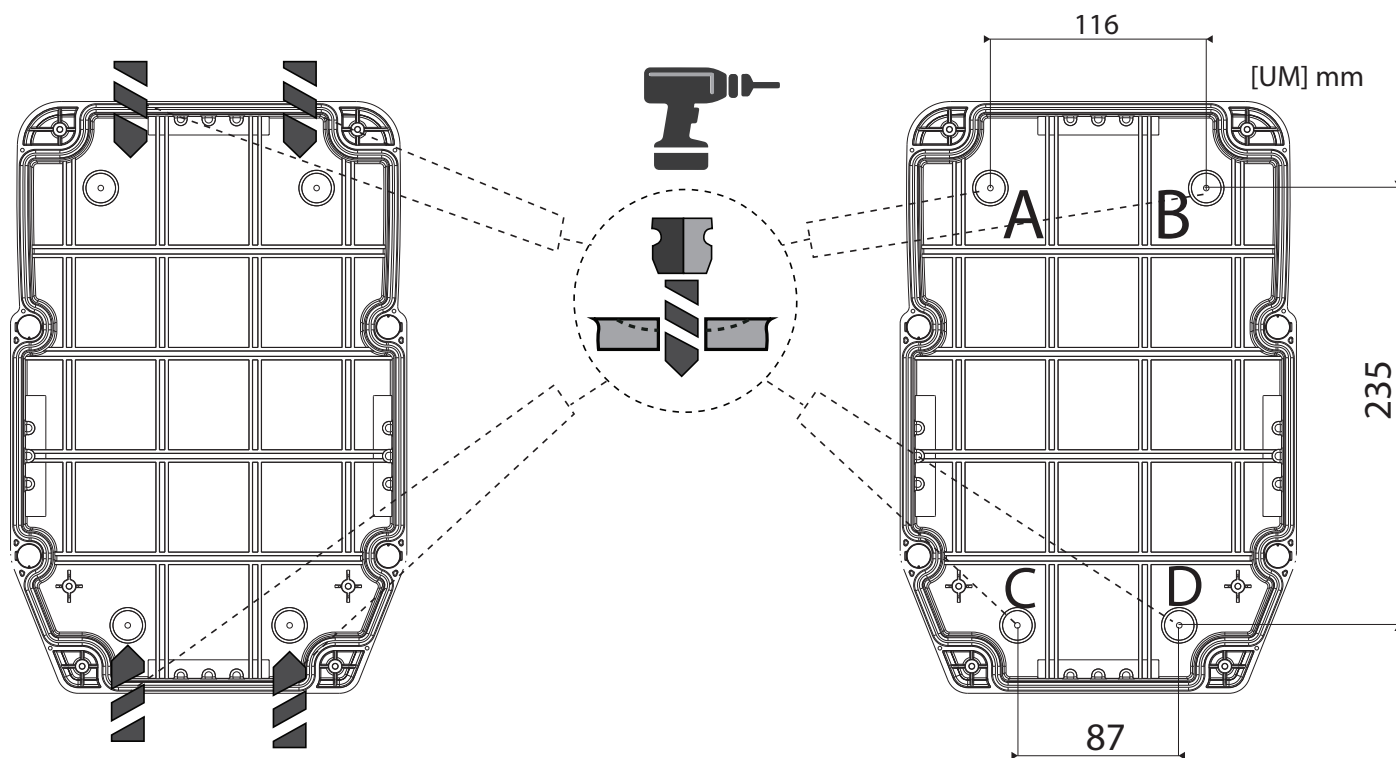

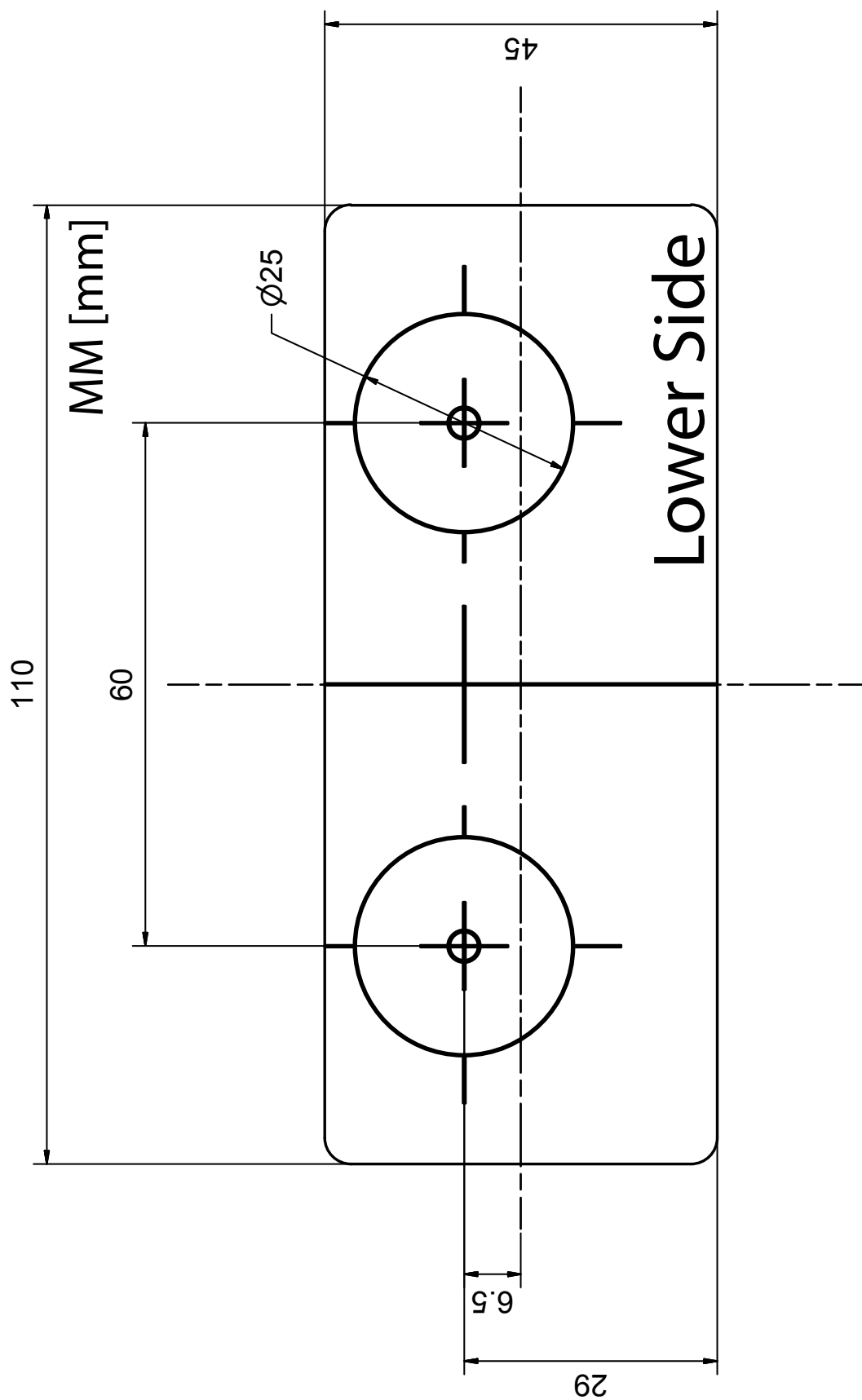

5. USER AND START-UP INTERFACE



5.1. DISPLAY

5.1.1. KEYS



No.	KEY	press and release	press and hold for about 3 seconds	NAVIGATION MENU	Notes
A	ESC key Defrost	<ul style="list-style-type: none"> • Functions menu 	<ul style="list-style-type: none"> • Manual defrost • Return to Main Menu 	<ul style="list-style-type: none"> • Output 	Configurable - see parameter H33
B	▲ UP Alarms	<ul style="list-style-type: none"> • Alarms Menu (always visible) 	/	<ul style="list-style-type: none"> • Scroll • Increase values 	HACCP alarms only in certain models and if available
C	SET	<ul style="list-style-type: none"> • Display SetPoint / probe values / time (Models with clock only) • Confirm values • Access value edit mode (upper display blinking) 	Access Parameters menu	<ul style="list-style-type: none"> • Confirm values • Move right 	Time only visible on models with clock
D	▼ DOWN AUX	<ul style="list-style-type: none"> system INFO See Technical Support 	Activate auxiliary function	<ul style="list-style-type: none"> • Scroll • Decrease values 	Configurable - see parameter H32
E	ON/OFF	/	On/Off device	/	Configurable - see parameter H34
F	LIGHT	Switch light on/off	Switch light on/off	/	Configurable - see parameter H35



5.1.2. LEDS

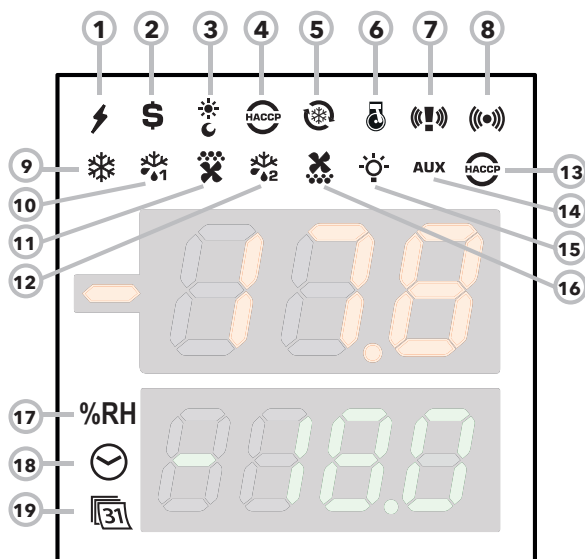

Meaning of LEDs:

No.	LED	Colour	Description
17	%RH	amber	not used
18	TIME	amber	access in case of time display or editing
19	DATA	amber	access in case of date display or editing

No.	LED	Colour	ON	BLINKING	OFF
1	POWER SUPPLY	green	Power supply ON	/	Power supply OFF
2	ENERGY SAVING	amber	Energy saving ON	/	Energy saving OFF
3	NIGHT & DAY	amber	Night & Day ON	/	Night & Day OFF
4	HACCP	amber	HACCP menu	/	/
5	DEEP COOLING (DCC)	amber	Deep cooling cycle ON	/	Deep cooling cycle OFF
6	PUMP DOWN	amber	Compressor Pump Down ON	/	Compressor Pump Down OFF
7	PANIC	red	Panic alarm	/	No alarm
8	ALARM	red	Alarm	Silenced	No alarm
9	COMPRESSOR	amber	Compressor ON	delay	Compressor OFF
10	DEFROST 1	amber	defrost	dripping	No defrost
11	EVAPORATOR FANS	amber	Fans ON	forced ventilation	Fans OFF
12	DEFROST 2	amber	defrost	dripping	No defrost
13	HACCP ALARM	red	HACCP alarm	Not displayed	No alarm
14	AUXILIARY (AUX)	amber	AUX ON	/	AUX OFF
15	LIGHT	amber	Light ON	/	Light OFF
16	CONDENSER FANS	amber	Fans ON	/	Fans OFF

ON: function/alarm ON; OFF: function/alarm OFF



5.1.3. PRELIMINARY CONFIGURATIONS

After making the electrical connections, simply power up the device to start operation.

At first start-up, Eliwell recommends that you:

1. Make sure the instrument is powered (green POWER SUPPLY LED on).
2. Make sure the display is working: when the controller is powered up it performs a lamp test, during which time the display and LEDs will blink for several seconds to ensure that they all function correctly.
3. Make sure there are no active alarms (ALARM / HACCP ALARM LEDs off and labels E1, E2 and E3 not displayed).
4. Configure the main parameters listed in the USER menu to suit your requirements, as described below.

5.1.4. OPERATION IN DEFAULT CONFIGURATION

The instrument is configured for negative cold. For positive cold, disable the evaporator probe Pb2 (set H42=n) and set relay OUT3 (parameter H23=6) to prevent continuous ventilation.

COMPRESSOR

The compressor is active if the cold room temperature detected by Pb1 exceeds the value of SEt + differential diF. The compressor stops if the cold room temperature detected by Pb1 falls below the SEt value. The instrument includes compressor on/off protection*.

DEFROST

Defrost is by means of electric heaters (parameter dty = 0) and the time counter is always active with the instrument switched on (dCt=1).

Manual defrost

Manual defrost is activated by pressing and holding the ESC key (A).

If conditions for defrosting are not present, (e.g. the evaporator probe temperature is higher than the defrosting end temperature) or the parameter OdO≠0, the display will blink three times to indicate that the operation will not be performed.

Default Defrost settings

dit = 6 hours. interval between 2 defrost cycles

dSt = 6.0°C. defrosting end temperature set by Pb2.

The Defrost cycle may terminate due to timeout based on the parameter dEt (default 30 min).

EVAPORATOR FANS

Relay OUT3 is configured as fans relay and is activated in the required cases, according to delays and parameter settings*.

Default fan settings

dt = 0 min. dripping time

dFd = Y. Fans off during defrosting.

LIGHT - EWRC 500 NT only

The light is activated by pressing and holding the LIGHT key (F).

Since digital input D.I. 1 is configured as door switch, relay OUT4 (light) is activated when the door is opened. The light also switches on with the instrument in stand-by*.

ALARM RELAY - EWRC 500 NT only

Relay OUT5 is configured as alarm relay and is activated in the case of alarms, according to delays and parameter settings.



5.1.5. NAVIGATION

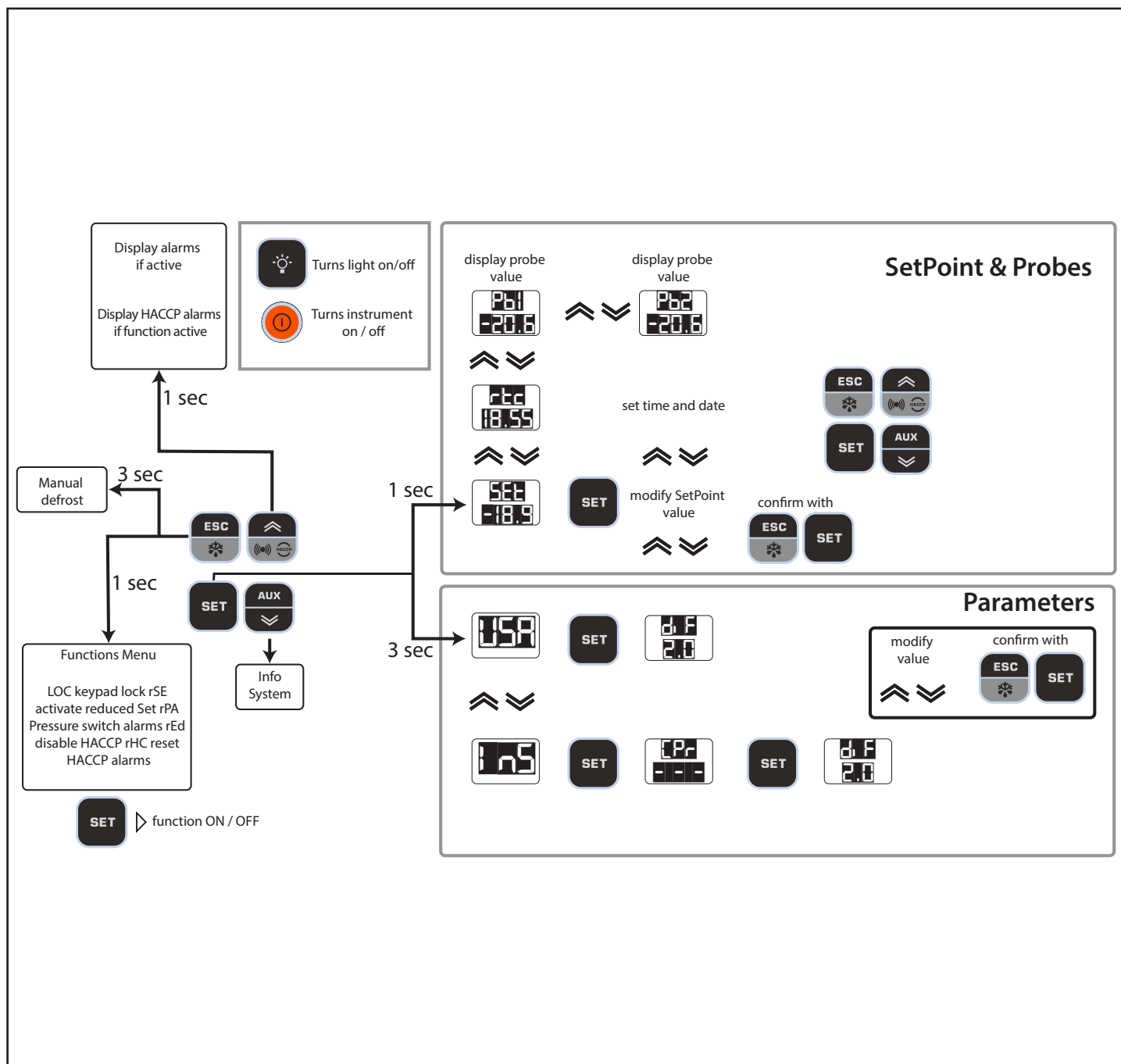



5.1.6. FUNCTIONS MENU AND KEY-ACTIVATED FUNCTIONS

The Functions menu is used to perform a number of manual functions such as putting the device into stand-by, clearing pressure switch interventions and clearing HACCP alarms, etc.

Access the Functions menu by pressing the ESC key.

The following table lists the functions, which are all OFF by default.

Display	Function	Description
	Keypad lock	The UP/ES/ON-OFF/LIGHT keys and the functions programmed via keys are locked The DOWN key may be used to view the Setpoint only; the value cannot be modified Only function visible if keypad locked (On)
	Disable HACCP alarm recording	Disables HACCP alarm recording
	Reset pressure switch alarm	Clears pressure switch alarm NOTE: the function reverts to OFF status when you exit the Functions Menu
	Reduced set (Economy setpoint)	Reduced set (Economy setpoint)
	Reset HACCP alarms	Clears HACCP alarms May be protected by Password PA3

All models have the **UP** key set to display the Alarms Menu.

All models also allow the setting of other keys to activate a specific function as identified by the client.

The parameters for configuring the two keys are:

- **H32** = DOWN key configuration
- **H33** = ESC key configuration
- **H34** = ON/OFF key configuration
- **H35** = LIGHT key configuration

The values that can be set apply to these keys and the functions that can be activated are:

Value of H32/H33/H34/H35	Function enabled
0 = Disabled 1 = Defrost 2 = Auxiliary 3 = Activate economy setpoint 4 = Reset HACCP alarms 5 = Disable HACCP alarms 6 = Light 7 = Stand-by 8 = NOT USED 9 = Evaporator fans ON	10 = Activate / deactivate Frame Heater relay 11 = Enable/disable Night And Day functions 12 = Deep cooling cycle 13 = Clear voltage drop errors (Power Failure Reset) 14 = Service stoppage 15 = Activate economy set + Night And Day



5.1.7. PASSWORD

Password PA1 is disabled by default.

Password PA1: allows access to **User** parameters.

To enable it (**PA1≠0**): press and hold **set** for at least 3 seconds. The label **USr** appears. Press **set** again.

Scroll through the parameters using **UP** and **DOWN** until you find label **PA1**, press **SEt** to display its value, change it using **UP** and **DOWN** and save it by pressing **set** or **ESC**.

Example with password enabled (PA1≠0) it will then be requested before access to the User parameters is granted.

Display	Description
	Press SET for 3 seconds
	Label PA1 appears
	Press SET Use UP and DOWN keys to enter the password
	Example the password is 12 Press SET
	User menu accessed The first User parameter appears If the value entered is incorrect, label PA1 will be shown again and the procedure must be repeated.

Password "PA2": allows access to **Installer** parameters.

The example is the same. N.B. Password **PA2** is set by default to **15**

Display	Description
	Press SET for 3 seconds
	Label USr appears Use 'UP' and 'DOWN' to search for InS



Display	Description
	Press SET
	Use UP and DOWN keys to enter the password
	Example the password is 15 Press SET
	User menu accessed The first User parameter appears If the value entered is incorrect, label PA2 will be shown again and the procedure must be repeated.







5.1.8. SETTING THE SETPOINT

By way of example, we will change the Setpoint value from -18.0 degrees centigrade to -20.0 degrees centigrade.

Display	Description
	Press and release the SET key
	The upper display will show SEt, the lower display will indicate the current SetPoint value Press and release the SET key once more
	The upper display will show SEt blinking Use the UP & DOWN keys to adjust the SetPoint value
	Press the ESC key several times to return to the normal display (or press the SET key to confirm, followed by ESC to exit)
	The new Setpoint value is saved and appears on the lower display



5.1.9. VIEWING PROBE VALUES

Display	Description
	Press and release the SET key
	The upper display will show SET, the lower display will indicate the current SetPoint value Use the DOWN key to view the value of probe Pb1
	The time is displayed in HACCP models
	Use the DOWN key again to view the value of probe Pb1
	Use the DOWN key again to view the value of probe Pb2
	If H43 is not 0 (probe 3 present) Use the DOWN key again to view the value of probe Pb3
	Press the ESC key to return to the normal display Normal display



5.1.10. HOW TO MODIFY THE DATE AND TIME

Function only available in HACCP models

Display	Description
	Press and release the SET key
	The upper display will show SET, the lower display will indicate the current SetPoint value Use the DOWN key to display the time
	The CLOCK LED is on Press and release the SET key
	The CLOCK LED is on <u>The hour value will begin to blink</u> Use the UP & DOWN keys to adjust the hour value
	The CLOCK LED is on Press and release the SET key
	The CLOCK LED is on The hour value has been changed <u>The minute value begins to blink</u> Use the UP & DOWN keys to adjust the hour value
	Repeat this procedure to adjust the date value (DAY.MONTH and YEAR)
	In this case the DATA LED (31) is on Press the ESC key several times to return to the normal display



5.1.11. DISPLAYING ALARMS

Display	Description
	<p>Press and release the UP key The upper display will show ALr</p>
 	<p>The lower display will show</p> <p>a. nOnE if no alarms active</p> <p>b. SYSt if system alarms present</p>
	<p>HACCP models ONLY</p> <p>The upper display will show ALr</p> <p>The lower display will show HACCP if HACCP alarms are present NOTE: parameter H50 must = 1</p>

5.1.12. SYSTEM ALARMS EXAMPLE

Let us suppose two alarms have occurred,

- one HIGH TEMPERATURE on the cold room probe
- one HIGH TEMPERATURE on probe 3 (parameter H43 different from 0)

Display	Description
	<p>Press and release the UP key</p>
	<p>The upper display will show ALr</p> <p>The lower display will indicate SYSt Press and release the SET key</p>
	<p>The upper display will show ALr</p> <p>The lower display will show HA1 HIGH TEMPERATURE alarm on the cold room probe</p> <p>Use the UP & DOWN keys to view other alarms, if present</p>
	<p>In the example, the lower display will indicate HA3 HIGH TEMPERATURE alarm on probe 3 (see para. H43)</p> <p>Press the ESC key several times to return to the normal display</p>



5.1.13. MODIFYING A PARAMETER

The User parameters **USr** are the most frequently used ones and are NOT grouped into sub-folders.

They are always visible by default (access password PA1 is not enabled by default).

The same parameters are also visible in the respective folders 'Compressor', 'Fans', etc. within the Installer parameters menu **InS**.

They are always visible by default (access password PA2 is not enabled by default).



NOTE: It is advisable to switch the device off and on again each time the configuration of the parameters is changed, so as to prevent malfunctions affecting the configuration and/or the current timings.

5.1.13.1 How to modify a user parameter





Instructions are provided below on how to modify a User parameter.

The same procedure applies to Installer (**inS**) level parameters.

Let us take the **dit** parameter as our example.

There are no sub-folders at User level. At Installer level the parameter is in the folder containing **dEF** defrost parameters.

We will now demonstrate how to change the value from **6h to 8h**.

Display	Description
	Press and hold the SET key for approx. 3 seconds
	The folder for USr parameters will appear Press and release the SET key Press and release the SET key to access the first parameter
	The first User parameter appears Use the UP & DOWN keys to find the parameter that you wish to modify
	Press and release the SET key The dit label will blink Use the UP & DOWN keys to adjust its value
	Press and release the SET key to confirm the modification



5.1.13.2 How to modify an Installer parameter

Instructions are provided below on how to modify the same User parameter but via the Installer menu.

Let us take the **dit** parameter as our example.

At Installer level the parameter is in the folder containing **dEF** defrost parameters.

We will now show how to change the value from **8h** to **6h**.

Display	Description
	Press and hold the SET key for approx. 3 seconds
	<p>The folder for USr parameters will appear Use the UP & DOWN keys to search for the inS folder Press and release the SET key</p> <p>Press and release the SET key to access the first parameter</p>
	<p>The first folder appears</p> <p>Use the UP & DOWN keys to search for the dEF folder</p>
	<p>Press and release the SET key</p> <p>The first parameter in the dEF folder will appear Use the UP & DOWN keys to find the parameter you want to change</p>
	<p>Press and release the SET key The dit label will blink Use the UP & DOWN keys to adjust its value</p> <p>Press and release the SET key to confirm the modification</p>

6. FUNCTIONS AND REGULATORS



This section describes the various functions of the devices.



IMPORTANT: some functions may not be available in certain models.

6.1. SETTINGS

6.1.1. PROBE SETTING AND CALIBRATION

EWRC 300/500 NT have 3 configurable NTC/PTC inputs (PB1 ... PB3).

The temperature probes (PB1 ... PB3) must all be the same type and should be configured via parameter **H00**, visible at User level (**USr**) inside the **CnF** folder at Installer level (**inS**).

- **H00** = 0 if using PTC probes
- **H00** = 1 if using NTC probes (default)

After installation, the values read by the probes can be corrected/calibrated using the following parameters:

- **CA1**: probe 1 offset. Positive or negative value to be added to the value read by Pb1 (Range: **-30.0 ... +30.0**)
- **CA2**: probe 2 offset. Positive or negative value to be added to the value read by Pb2 (Range: **-30.0 ... +30.0**)
- **CA3**: probe 3 offset. Positive or negative value to be added to the value read by Pb3 (Range: **-30.0 ... +30.0**)

6.1.2. DISPLAY SETTINGS

At User level (**USr**) or inside the **diS** folder at Installer level (**inS**) you will find the parameters used to set the temperature readout, decimal point usage, unit of measure and display during defrost.

- **ndt**: (**USr/inS**) enables/disables decimal point display (with resolution of one-tenth of a degree; e.g.: 10.0°C). Display with decimal point is only possible within the range of values from -99.9°C to +99.9°C
 - **ndt = y** → displays read values with decimal point (**default**)
 - **ndt = n** → displays read values without decimal point



NOTE:

enabling/disabling the decimal point only affects the on-screen display of values. The controller will continue to perform calculations with decimal point.

- **ddl**: (**USr/inS**) sets the type of display during and up to the end of defrost.
 - **ddl = 0** → displays the probe value (**default**)
 - **ddl = 1** → continues to display the value read by the probe at the start of defrosting
 - **ddl = 2** → displays fixed label **DEF**
- **dro**: (**inS**) sets temperature display to °C or °F.
 - **dro = 0** → display in °C (**default**)
 - **dro = 1** → display in °F



IMPORTANT : switching between °C and °F DOES NOT modify the values of temperature parameters (e.g. setpoint=10°C becomes 10°F).

This means that the maximum and minimum limits of parameters as absolute values are the same for both units of measure and hence the ranges are different.

- **ddd**: (**inS**) establishes the value to be shown on the upper display. All other display and adjustment modes are the same.
 - **ddd = SEt** → displays the Setpoint value (**default**)
 - **ddd = Pb1** → displays the values read by Pb1
 - **ddd = Pb2** → displays the values read by Pb2
 - **ddd = Pb3** → displays the values read by Pb3



6.2. FUNCTIONS

6.2.1. UPLOAD, DOWNLOAD, FORMAT

Description

The Unicard/Multi Function Key is connected to the serial port (TTL) and allows fast programming of instrument parameters.



DOWNLOAD from reset operating mode: at power-on, if the Unicard/Multi Function Key is inserted in the device, the controller automatically downloads data.

After connecting the Unicard/Multi Function Key with the device switched off and on completion of the lamp test, one of the following labels will be displayed:

- **dLY** if the operation was successful
- **dLn** if the operation was not successful

After about 5 seconds, the display will display the probe or setpoint value, depending on the default settings.



IMPORTANT: once download has been completed successfully, the controller will start to work with the new map loaded.

Operating mode: access "Installer" parameters by entering the password "**PA2**" if enabled (PA2≠0), scroll through the folders using **UP & DOWN** until the "**FPr**" folder appears. Select it using **SET**, scroll through the parameters using **UP & DOWN** and then select one of the functions by pressing **SET**:

- **UL** (Upload): This function uploads the programming parameters from the instrument to the card. If the operation is successful, the display will show "**y**", otherwise it will show "**n**".
- **Fr** (Format): This command is used to format the copy card (which is necessary when using the card for the first time). Important: the **Fr** parameter deletes all data present and this operation cannot be reversed.
- **Download:** Connect the UniCard/Multi Function Key with the instrument switched off. At power-up, data will automatically start downloading from the Unicard/Multi Function Key to the controller. At the end of the lamp test, the display will show "**dLy**" if the operation was successful and "**dLn**" if it failed.



IMPORTANT: before Uploading or Downloading a map, make sure that communication with the supervisor (PC with Televis, TelevisGo system, etc.) has been cut off. This means you should make sure that the RS485 is disconnected from the instrument or that Supervision system acquisitions have been stopped.

Parameters

The parameters that control this function are:

Label	Description
UL	Transfer programming parameters from instrument to Unicard/MFK COLDFACE → Unicard/MFK
dL	Transfer programming parameters from Unicard/Multi Function Key to instrument Unicard/MFK → COLDFACE
Fr	Format the UniCard/Multi Function Key. Erases all data on the UNICARD/MFK



6.2.2. MULTI FUNCTION KEY

The Multi Function Key lets you download/upload a parameter map from/to a controller. Regardless of whether you are down or uploading a parameter map, the controller must be connected to a power supply and switched on.



6.2.3. UNICARD

The UniCard lets you download/upload a parameter map from/to a controller, in the same way as the Multi Function Key. It is a versatile tool that also allows you to quickly and easily customise devices. It differs from the Copy Card in the following ways:

- 1) It can be connected directly to a computer via USB
- 2) it can be plugged into a USB socket or USB battery, to power the device directly during upload/download procedures.

The Unicard can be powered in the following ways:

A) Cabinet powered

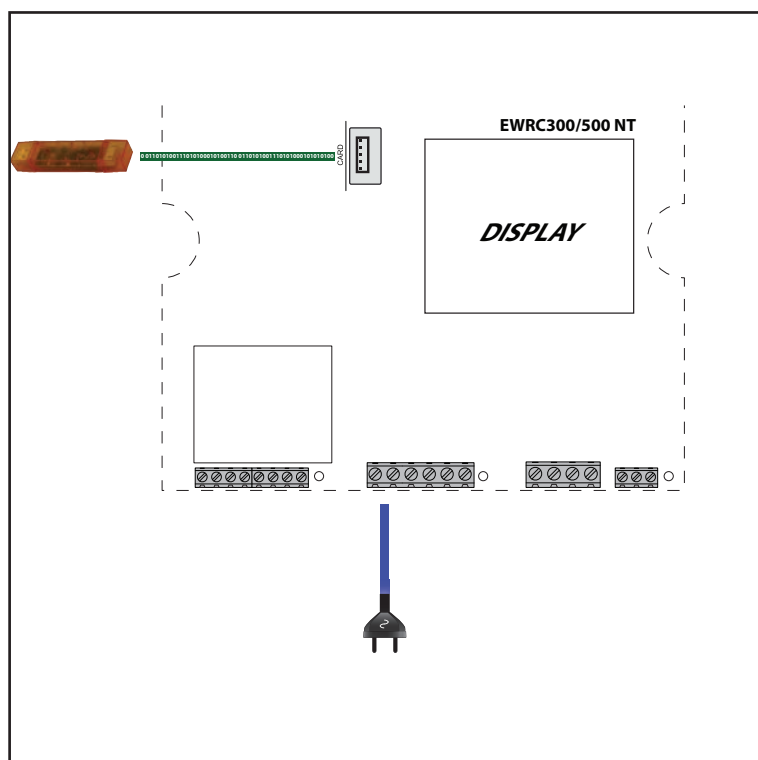

B) Site powered

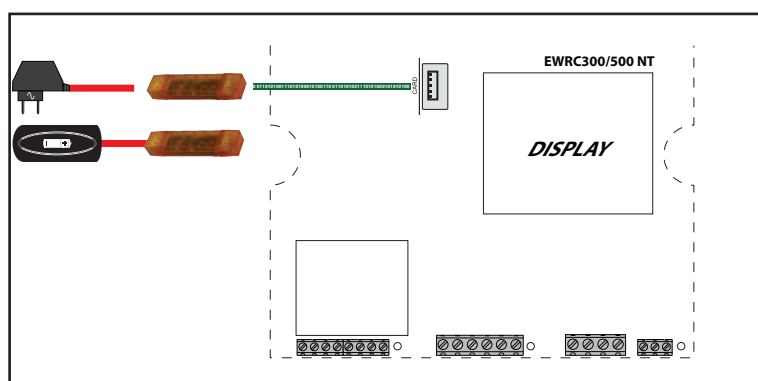



6.3. BOOT LOADER FIRMWARE

The device is equipped with a Boot Loader, so it is possible to update the Firmware directly on site. Updating may be carried out using UNICARD or MULTI FUNCTION KEY (MFK).

Updating procedure:

- Connect the UNICARD/MFK equipped with the application;
- Power the device if it is off, otherwise switch it off and on again



NOTE: the UNICARD/MFK can be connected even with the instrument powered.

- Wait until the green LED of the UNICARD/MFK is blinking (operation in progress). Note: Steady red LED ONLY for UNICARD;
- The operation will be concluded when the green LED of the UNICARD/MFK is:
 - **ON:** operation concluded correctly
 - **OFF:** operation not performed (application not compatible...)



IMPORTANT: the LED display is guaranteed only for UNICARDS produced from week 18-12 onwards.

In order to download the Firmware application on the UNICARD (in CLONE mode as used for parameters maps) you must use the Device Manager (version 05.00.06 or later), which you can download from the Eliwell site after having registered at level 2.



NOTE: with this version of the Device Manager the UNICARD can be connected DIRECTLY without using the DMI.



6.4. COMPRESSOR

The compressor is controlled by the device's relay. It will be switched on or off depending on:

- the temperature status readings from the cold room probe
- the temperature control functions set
- the defrost/dripping functions (see Defrost section)

6.4.1. COMPRESSOR CONFIGURATION

See the wiring diagrams for details of how to connect the compressor to the device.

Relay polarity is fixed.

NOTE: you MUST check the Compressor → digital output (relay) association by setting parameter **H2x** accordingly.

NOTE: by default **H21 = 1 (compressor)**

6.4.2. SECOND COMPRESSOR CONFIGURATION

Coldface offers the option of using a second compressor.

NOTE: you MUST check the Compressor 2 → digital output (relay) association by setting parameter **H2x** accordingly.

For example **H25 = 10 (compressor 2)**.

NOTE: to prevent the two compressors from starting up with an insufficient interval in between, an activation delay can be set for the second compressor using the **dSC** parameter

6.4.3. COMPRESSOR OPERATING CONDITIONS

Compressor operation

The regulator is active when:

- the device is ON
- there is no control probe fault alarm **E1**
- the time set in parameter **Odo** has elapsed
- a defrost cycle is not underway (except in FREE mode)

(There is a fixed interval of one second between the request and activation of the relay)

The parameters that control this regulator are:

- the setpoint that can be set via the keypad, with a range from minimum to maximum setpoint
- the differential

The diagram below indicates the compressor activation mode for cooling based on parameters **SEt** and **diF** > 0.

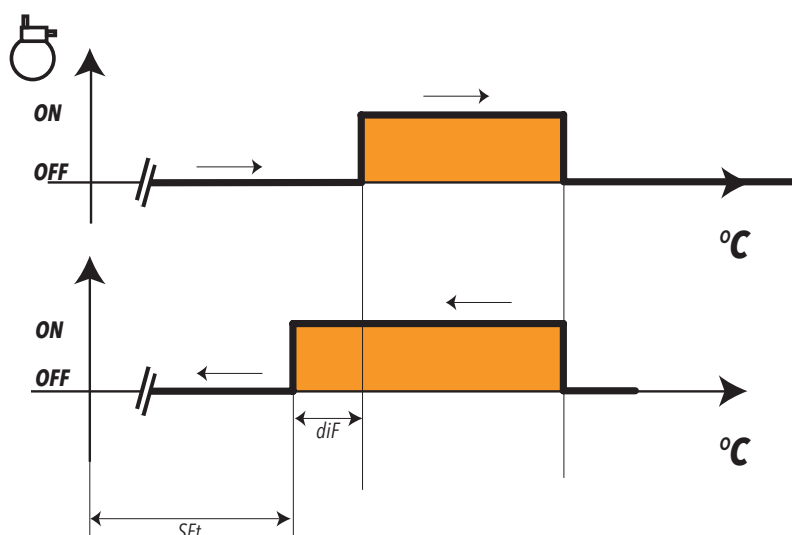



6.5. COMPRESSOR/GENERAL PROTECTIONS

Description

If the cold room probe is in error **E1** the output relay configured as compressor/general regulates in accordance with the times set in parameters **Ont** and **OFt**.

The first time to consider is **Ont**.

If **Ont > 0**, the protection programmed in parameters **dOn-dOF-dbi** must be respected (see Compressor Safety Times).



NOTE: You are reminded that parameter **Odo** inhibits the activation of all outputs commanding a relay for its entire duration (compressor/general, defrost, fans), excluding buzzers or alarm relays.

Operating conditions

The table below lists the ways the compressor relay output can be managed:

Ont	OFt	Compressor OUT
0	0	OFF
0	>0	OFF
>0	0	ON
>0	>0	DUTY CYCLE

If **Ont > 0** and **OFt = 0** the compressor regulator entrusts relay deactivation to the safety protection **CAt**.

If **Ont > 0** and **OFt > 0**, the compressor regulator activates in operating cycle mode irrespective of the values read by the probes (cold room probe failure) and of requests from other loads (**Duty Cycle** mode).

If the cold room probe is working properly, the Duty Cycle mode does **NOT** activate as it does not have priority over normal compressor regulator settings.

The following diagram shows the **Duty Cycle** operating mode based on parameters **Ont** and **OFt > 0**:

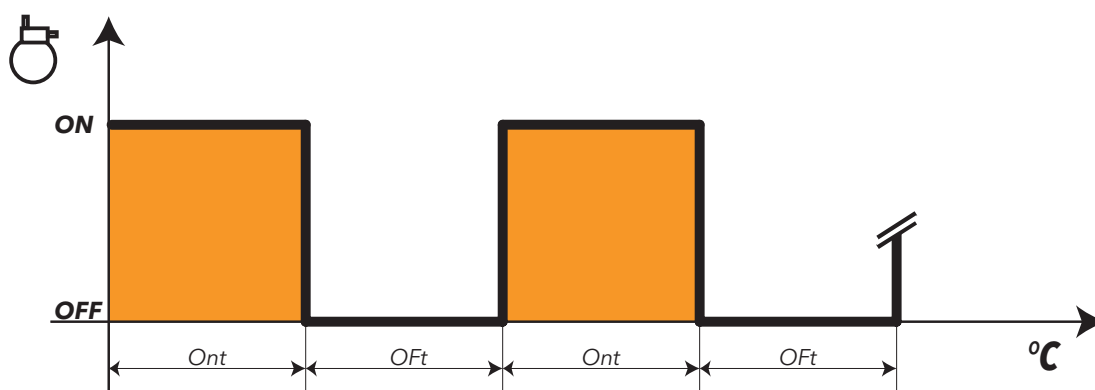



6.5.1. COMPRESSOR SAFETY TIMINGS

Compressor on-off operations must respect the safety times that you can set using the special parameters as described below.

The compressor LED will flash to indicate when an activate compressor request has been received but a safety protection exists.

A safety time (compressor On... Off safety time) regulated by the parameter **dOF** must be respected between a switch-off and switch-on of the same compressor. This waiting time also occurs at switch-on of the device.

A safety time regulated by the parameter **dbi** must be respected between one switch-on and the next.

The safety time set in parameter **dOn** must elapse between a start-up request and actual start-up.

Times set with parameters **dOn**, **dOF** and **dbi**, if active, are not accumulative but parallel.

The following diagram illustrates the operation of the compressor protection with parameters **dOn**, **dOF**, **dbi** set where:

IN	Input status for Compressor regulator.
OUT	Output status for Compressor regulator.

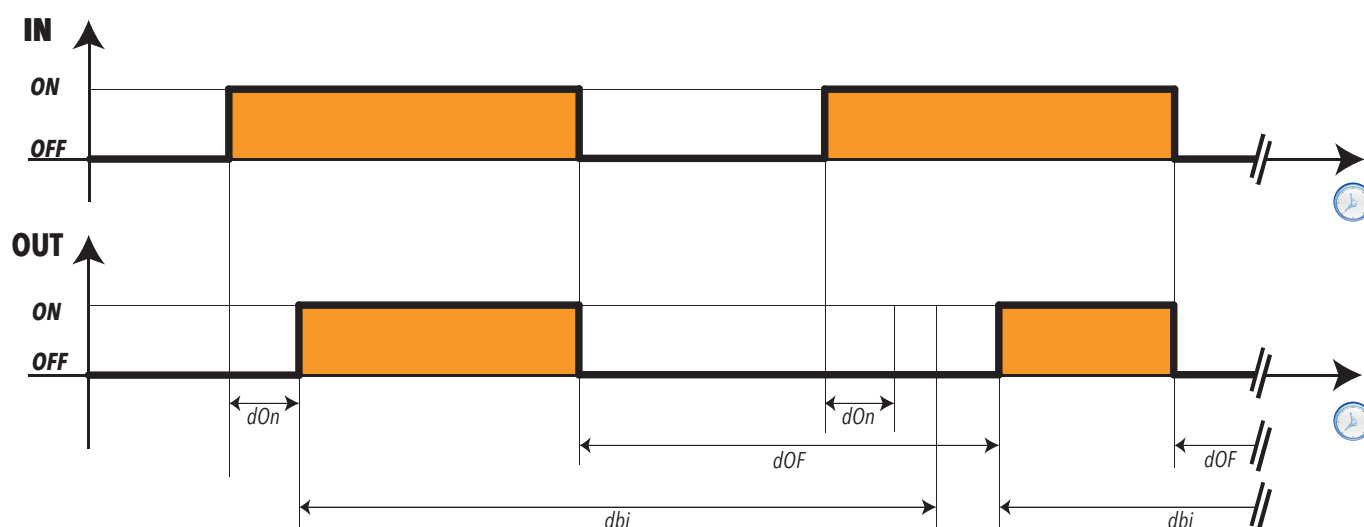

NOTE: See the section entitled Compressor Function During Defrost for other safety measures and compressor timings.

Maximum timer period

The maximum compressor activation time before its deactivation can be set via the parameter **CAt**.

Minimum timer period

The minimum compressor activation time before its deactivation can be set via the parameter **Cit**.

User parameters

The parameters that manage this regulator are:

Label	Description
Ont	Compressor output ON time in the event of a faulty Pb1 probe
OFt	Compressor output OFF time in the event of a faulty Pb1 probe
dOn	Compressor output activation delay from request
dOF	Compressor output activation delay from shutdown
dbi	Delay between two consecutive starts of the compressor output
OdO	Output activation delay from power-on
Cit	Minimum compressor output activation time
CAt	Maximum compressor output activation time



6.6. DEFROST/DRIPPING

6.6.1. DEFROST TYPE AND ACTIVATION

Defrost is used to stop ice from forming on the surface of the evaporator. Its **activation** can be:

- automatic, in one of the following modes selected via **dCt**:
 - compressor hours (Digifrost);
 - appliance hours;
 - compressor stopped;
 - via clock (see corresponding paragraph under RTC);
- via D.I.;
- via key;
- remote.

The **type** of defrost can be selected via the parameter **dtY** and can be:

1. defrost with electric heaters;
2. inverse;
3. FREE

Dripping

On completion of defrost, given that there will be water on the evaporator, it is better not to start "cooling" right away as this would ruin the effect of the defrost by creating ice immediately.

The dripping interval is regulated via parameter **dt**.

Defrost conditions and operation

Defrosting is enabled if:

- The evaporator temperature, read by probe 2, is lower than the defrost end setpoint configured via parameter **dSt**.
- Manual defrosting has not already been activated, in which case the request for automatic defrost will be cancelled.

Defrost requests can be made in the following ways:

Controller power-on	If parameter dPO (defrost at power-on) is programmed accordingly.
Time intervals	If dit > 0 whenever the defrost time interval set in parameter dit elapses.
Manually (via key)	By pressing the UP key. The cycle will not start if OdO ≠ 0, the request will be refused and the display will flash three times to indicate that defrost is impossible.
External request via D.I.	If D.I. appropriately configured. Activation from D.I. respects the protections of the automatic cycle. The cycle will not start if OdO ≠ 0, the request will be refused and the display will flash three times to indicate that defrost is impossible.

HACCP models also offer the following mode:

Time	if dit = 0 and dCt =3 with rtc function (real time clock) present. At the times set in parameters dE1...dE8 (dd folder).
------	---



6.6.2. AUTOMATIC DEFROSTING

The defrost cycle is programmed to start at intervals.

 **NOTE:** To disable the automatic cycle, set **dit**=0.

If **dit**>0, then defrost cycles will be run at fixed intervals, as indicated in parameter **dit**, and the interval time is counted as follows:

Par.	Value	U.M.	Description	Notes
dCt	0	num	Hours of compressor operation (DIGIFROST® method)	In this case, the counter runs only if the compressor is on. A new count starts when the defrost interval elapses and a new defrost cycle starts if conditions permit. NOTE: compressor running time is counted separately from the evaporator temperature. If the evaporator probe were missing or faulty, the count would still be active for the period of activity of the compressor.
	1	num	Controller running time	The defrosting interval is counted continuously when the device is on and starts at each power-on. A defrost cycle starts when the defrosting interval elapses (indicated by dit) if conditions permit and the controller immediately starts counting a new defrosting interval.
	2	num	Compressor stop	Each time the compressor stops, a defrost cycle is run according to the mode set in parameter dtv .
	3	num	RTC (clock)	The clock can be used to set: • defrost times (6 bands for weekdays and 6 bands for weekends) • regular defrosts (every n days) • daily events (1 event for weekdays and 1 event for weekends) Time band defrosts and periodic defrost are mutually exclusive functions (they cannot be activated simultaneously). If defrost by RTC has been enabled and the clock has failed, the defrost will run according to the mode set in dit (provided the value is ≠ 0).



IMPORTANT: regardless of how the interval is counted, the following conditions apply:

If parameter **OdO** is underway or the temperature read by the evaporator probe is higher than **dSt**, then defrost will not be permitted: a new interval will be counted and only at the end of this subsequent count will conditions be tested for the start of a defrost cycle.

6.6.3. MANUAL DEFROST

If you press and hold **ESC** for manual defrost (or via D.I. if **H11 ... H12 = 1** is suitably configured), the appliance enters defrost mode. Procedures for the activation of this defrost cycle are the same as for external defrost.

The defrosting interval will now be counted as described for Automatic Defrost (time **dEt** is not cleared, it continues).

If the conditions for defrost activation are not present, i.e.:

- the time set in parameter **OdO** has not elapsed
- the evaporator temperature is higher than the value set in parameter **dSt**

this will be signalled on the display (screen flashes three times) and defrost will stop.

Manual defrost is always enabled except when **dit** = 0.



6.6.4. EXTERNAL DEFROST

If the Digital Input is configured for this function (if **H11 ... H18 = 1**) and if conditions permit, defrost can be requested and the relative regulator activated.

Time graphs for signals in each of the various function modes are presented below.



IMPORTANT: Defrost activation occurs when the signal is toggled and the polarity can be selected. Hence you can only activate a defrost, NOT stop one that is underway. Defrost or dripping currently underway and the defrost or dripping interval count cannot be suspended.

IN (Digital Input)	Input status for defrost regulator, with activation from Digital Input.
OUT (Defrost)	Output status for defrost regulator.
DurDI	Digital Input duration.
NOTE:	dSt indicates end defrost time when Setpoint temperature reached and dEt indicates end of defrost due to timeout.

The control diagram is as follows:

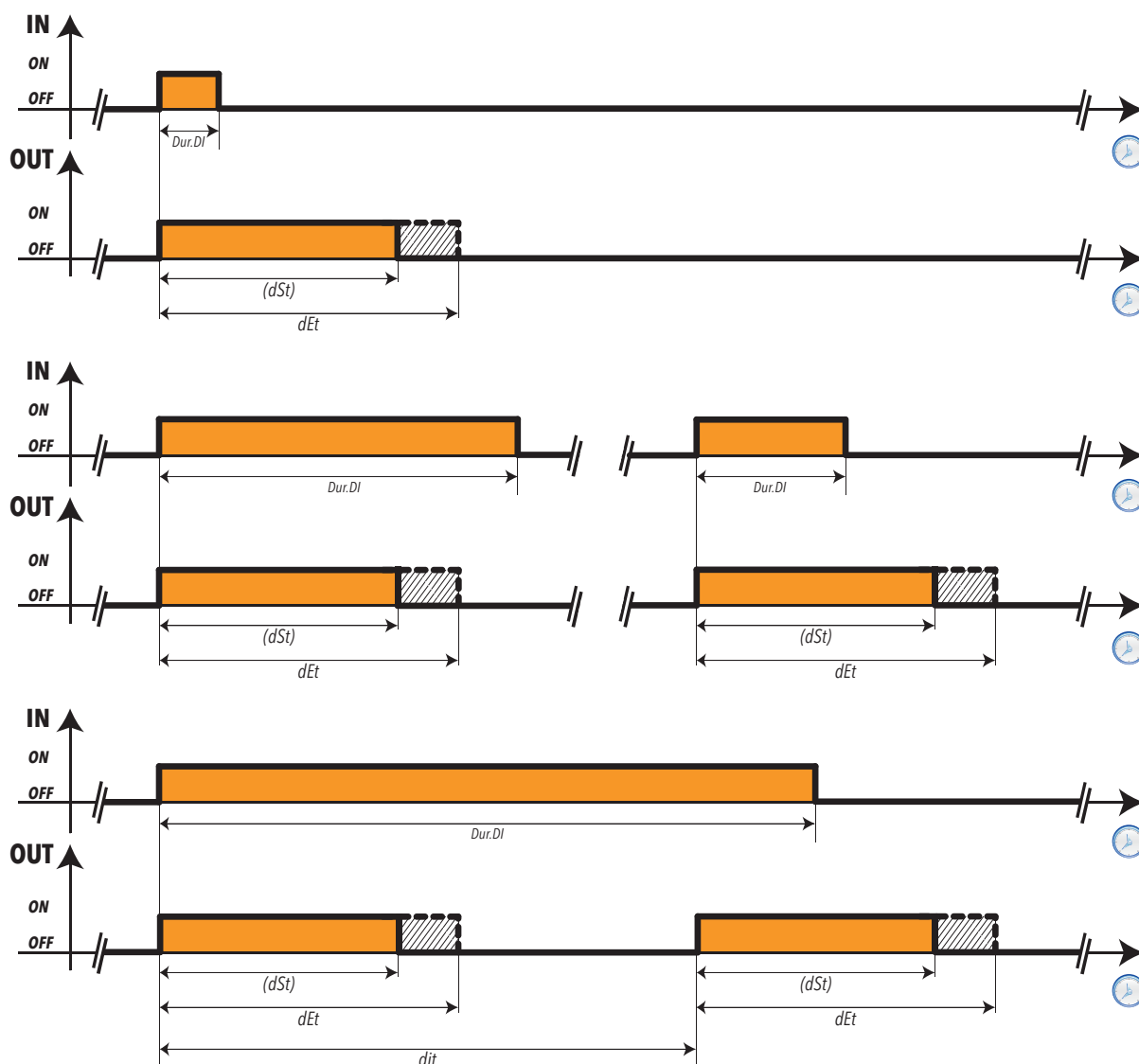



6.7. DEFROST MODE

6.7.1. DEFROST WITH ELECTRIC HEATERS

Defrost with electrical heaters is configured by setting **dtY = 0**.

The compressor remains stopped for the duration of the defrost cycle and the relay configured as defrost regulator output, to which the electrical heaters are connected, activates. On completion of defrost, the electrical heaters are switched off and the compressor remains off for the dripping time set in parameter **dt**, if it is not equal to zero.

Defrost ends due to:

Evaporator Probe	End of defrost description
Evaporator Probe ABSENT	Due to timeout set in parameter dEt (defrost timeout).
Evaporator Probe PRESENT	Temperature setpoint for the end of defrost set in parameter dSt reached. If this setpoint is not reached within the time set in parameter dEt (defrost timeout), the defrost will end due to timeout.

NOTES:

- If **dSt** intervenes before **dEt**, dripping (**dt** and **Fdt**) aligns with **dSt**.
- If **Fdt < dt** then **Fdt = dt**.
- During defrost, fans are OFF if parameter **dFd** is set accordingly, otherwise they will behave as set for the fan regulator.

The operating diagram is as follows:

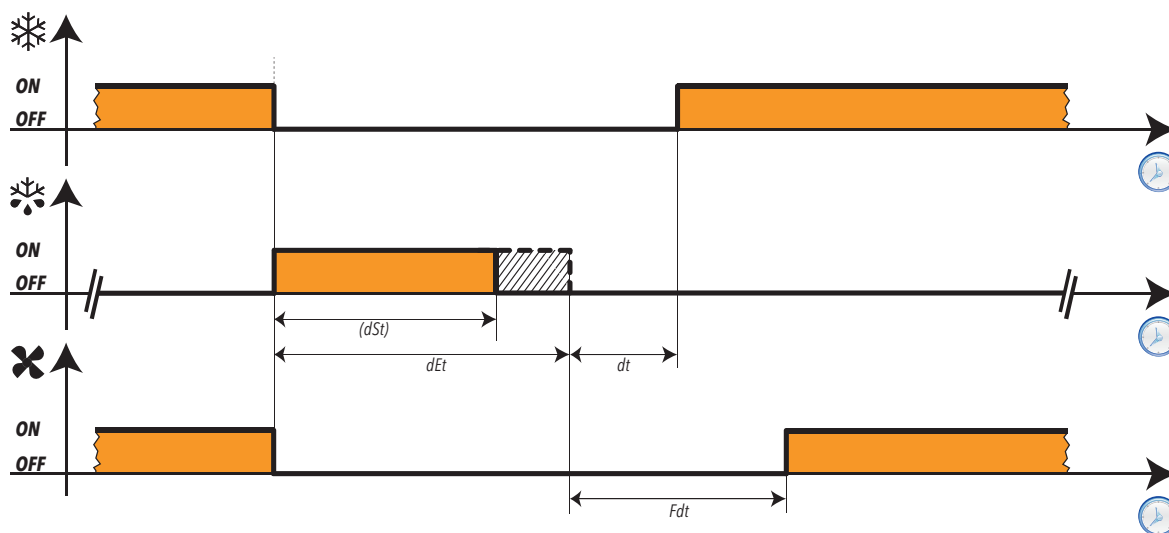

Legend:

	Output status for Compressor regulator
	Output status for Defrost regulator
	Output status for Evaporator Fan regulator



6.7.2. INVERSE DEFROST

Hot gas defrost is configured by setting parameter **dtY = 1**.

The compressor stays on for the entire duration of the defrost cycle and the relay configured as defrost regulator output, and that the solenoid valve is connected to, activates.

On completion of the defrost cycle, the solenoid valve relay is de-energised and the dripping phase set in parameter **dt** (if not equal to zero) is interrupted. The compressor relay is once again controlled by the compressor regulator.

Defrost ends due to:

Evaporator Probe	End of defrost description
Evaporator Probe ABSENT	Due to timeout set in parameter dEt (defrost timeout).
Evaporator Probe PRESENT	Temperature setpoint for the end of defrost set in parameter dSt reached. If this setpoint is not reached within the time set in parameter dEt (defrost timeout), the defrost will end due to timeout.



IMPORTANT: parameters **dOn**, **dOF** and **dbi** still have priority.

NOTES:

- If **dSt** intervenes before **dEt**, dripping (**dt** and **Fdt**) aligns with **dSt**.
- If **Fdt** < **dt** then **Fdt** = **dt**.
- During defrost, fans are OFF if parameter **dFd** is set accordingly, otherwise they will behave as set for the fan regulator.

The operating diagram is as follows:





6.7.3. DOUBLE EVAPORATOR DEFROST

The defrost for a second evaporator can be controlled via the probe configured as second evaporator.

Configure a relay output (see configuration parameters H21...H25) as a defrost relay for evaporator 2.

To enable this function, you need to:

- Set probe Pb3 to control defrost evaporator 2 mode (parameter H43).
- Configure a relay output (see configuration parameters H21...H25) as a defrost relay for evaporator 2.
- Define defrost mode by setting parameter H45.

Input mode

A double evaporator defrost can take place in three different ways on the basis of parameter **H45**, as described below:

- H45=0: Defrost is enabled only when the temperature of evaporator 1 is lower than the value set in parameter **dSt**.
- H45=1: Defrost is enabled when the readings from at least one of the two probes is below its defrosting end temperature (**dSt** for evaporator 1 and **dS2** for evaporator 2).
- H45=2: Defrost is enabled when both probe values are below the relative end of defrost setpoints (**dSt** for evaporator 1 and **dS2** for evaporator 2).

The probe error condition is considered as a probe calling for defrost.

The defrost for every single evaporator ends when the following conditions have been met:

- the **dEt/dE2** timeout period has begun
- the **dSt/dS2** temperature has been reached

Ending mode

for defrost in the case of a double evaporator takes place when both probe values have reached or exceeded the relative end of defrost setpoints (dSt for evaporator 1 and dS2 for evaporator 2).

If one or both probes are in error, the end of defrost will take place due to timeout.

In any case

If there are no conditions for performing the defrost the request will be cancelled.

The defrost for a single evaporator will end when the corresponding probe reaches or exceeds the defrosting end temperature or when the timeout period begins.

Dripping begins when both defrosts have ended.

If one or both probes are in error, the defrost for the corresponding evaporator will end due to timeout. Onset is allowed as if the corresponding temperature is lower than the corresponding setpoint (dSt or dS2).

If the probe is not configured to be the probe for the second evaporator ($H43 \neq 2$), the defrost for the second evaporator may take place if a digital output is configured to control defrost on the second evaporator ($H21..H25 = 9$). In this case consent for defrost will be granted, as if the probe temperature (2nd evap.) < dS2 and the output takes place due to timeout. The fan regulator is not affected.



User parameters

The parameters that manage this regulator are:

Label	Description
dy	Selects defrost type
dit	Time interval between 2 consecutive defrost cycles
dCt	Selects the count mode for the defrost interval
dOH	Defrost cycle activation delay after request
dEt	Defrost timeout, evaporator 1. Determines the maximum defrost duration
dE2	Defrost timeout, evaporator 2. Determines the maximum defrost duration
dSt	Defrost 1 end temperature - determined by evaporator probe 1
dS2	Defrost 2 end temperature - determined by evaporator probe 2
dPO	Determines whether the instrument must enter defrost mode at power-on
Fdt	Fan activation delay after a defrost cycle
dt	Dripping time
dFd	Allows exclusion of the evaporator fans to be selected or not selected during defrosting
dAO	Temperature alarm disabling time after defrost cycle
dAt	Alarm signalling end of defrost due to timeout
ddL	Display mode during defrost cycle (lock display)
Ldd	Timeout value for display unlock - label dEF

Summary table

Defrost on evaporator 1

Defrost START		Defrost END
If H45=0	Probe Pb3 temperature (evap. 2) (evap. 1) < dSt	Probe Pb3 temperature (evap. 2) (evap. 1) > dSt or if Probe Pb3 temperature (evap. 2) (evap. 1) < dSt due to timeout or if probe Pb2 in error due to timeout
If H45=1	Probe Pb3 temperature (evap. 2) (evap. 1) < dSt	
If H45=2	Probe Pb3 temperature (evap. 2) (evap. 1) < dSt and Probe temperature (evap. 2) < dS2	
Note: if the probe is in error or H43≠2 and a digital output is configured as a regulator for the second evaporator, the following condition applies: Probe temperature (evap. 2) < dS2		

Defrost on evaporator 2

Defrost START		Defrost END
If H45=0	Probe Pb3 temperature (evap. 2) (evap. 1) < dSt and Probe temperature (evap. 2) < dS2	Probe 3 temperature (evap. 2) > dS2 or if Probe temperature (evap. 2) < dS2 due to timeout or if probe in error due to timeout
If H45=1	Probe temperature (evap. 2) < dS2	
If H45=2	Probe Pb3 temperature (evap. 2) (evap. 1) < dSt and Probe temperature (evap. 2) < dS2	
Note: if the probe is in error or H43≠2 and a digital output is configured as a regulator for the second evaporator, the following condition applies: Probe temperature (evap. 2) < dS2		

Dripping

Drip cooling START		Drip cooling END
	End of defrost for both evaporators if defrosting takes place for both evaporators, otherwise end of the only defrost in progress.	Unchanged



6.8. EVAPORATOR FANS

6.8.1. EVAPORATOR FAN OPERATING CONDITIONS

The regulator is active when:

- the time set in parameter **OdO** has elapsed.
- the evaporator probe temperature is lower than the value of parameter **FSt**.
- during defrost it is not excluded by the parameter **dFd** (**dFd = On**).
- dripping is not active (**dt**).
- the fan delay is not active after defrost (**Fdt**).

The request to switch fans on or off can be made in the following ways:

- by the compressor regulator to help in the "cooling" process (temperature control mode)
- by the defrost regulator to check and/or limit the diffusion of hot air

	FCO	Compressor ON	Compressor OFF
Probe present and working	0	THERMOSTAT CONTROLLED	OFF
	1	THERMOSTAT CONTROLLED	THERMOSTAT CONTROLLED
	2	THERMOSTAT CONTROLLED	THERMOSTAT CONTROLLED
	3	THERMOSTAT CONTROLLED	DUTY CYCLE*
	4	THERMOSTAT CONTROLLED	DUTY CYCLE* **
Probe present but in error	0	DUTY CYCLE	OFF
	1	ON	OFF
	2	DUTY CYCLE	DUTY CYCLE
	3	DUTY CYCLE	DUTY CYCLE
	4	DUTY CYCLE	DUTY CYCLE
Probe absent	0	ON	OFF
	1	ON	ON
	2	DUTY CYCLE*	DUTY CYCLE*
	3	ON	DUTY CYCLE*
	4	ON	DUTY CYCLE* **

* see paragraph "Fan operation with Pb2 absent" (H42 ≠ 0).

** Normal Duty-Cycle operation reversed (OFF cycle - ON cycle)

The graphs below illustrate fan operation on the basis of the **FCO** value. In the graphs, we can see that:

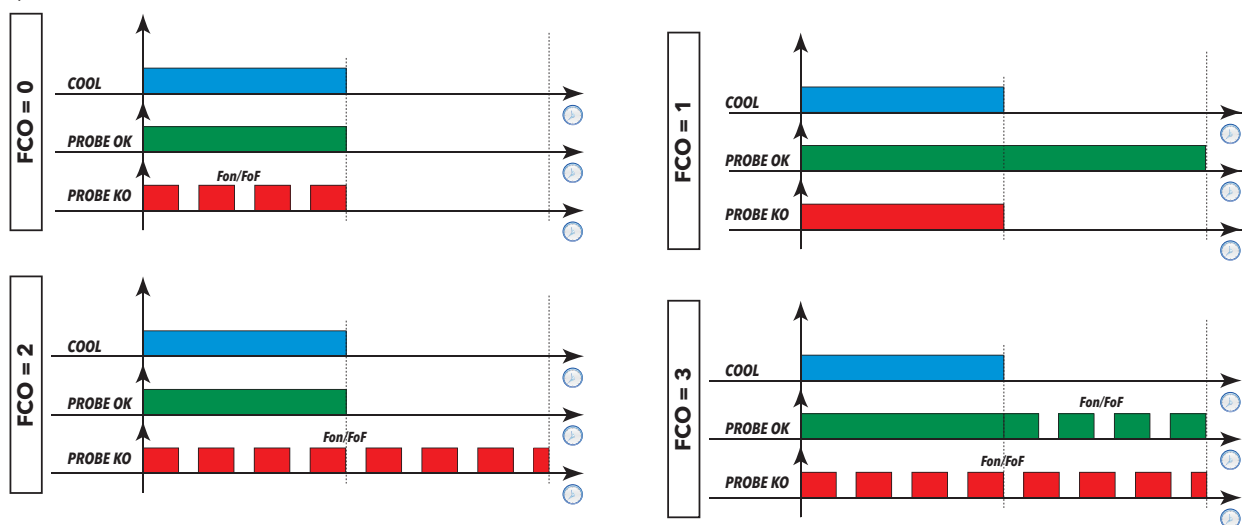

Legend:

COOL	Cooling
Probe OK	Fan operation with the probe present and working
Probe KO	Fan operation with the probe present but in error



6.8.2. FAN OPERATION IN THERMOREGULATION MODE

During "cooling", the fans operate as shown in this diagram:

Thermostat control of fans takes place at the values set in parameters

- **FSt** (fans disabling temperature) and **FAd** (fans differential).

The fan disabling temperature, set via parameters **FSt** (fan disabling temperature) and **FAd** (fan differential), is an absolute value as **FpT = 0** (actual temperature value).



IMPORTANT: Around the fan start temperature (-50°C) the differential will always take account of the parameter **FAd** but with the sign inverted.

The fan regulator operates as indicated below:

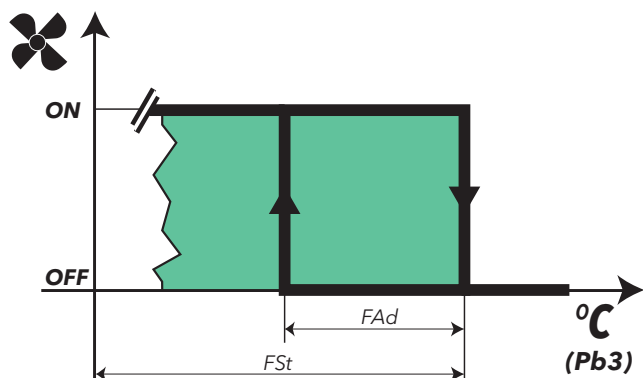

6.8.3. FAN OPERATION IN DUTY CYCLE MODE

For Duty cycle operation, parameters **Fon** and **FoF** must be set accordingly.

The fans operate as follows:

DUTY CYCLE

Fon	FoF	Fan operation
0	0	OFF
0	≠0	OFF
≠0	0	ON
≠0	≠0	DUTY CYCLE

The fan regulator will operate in Duty Cycle mode as illustrated below:

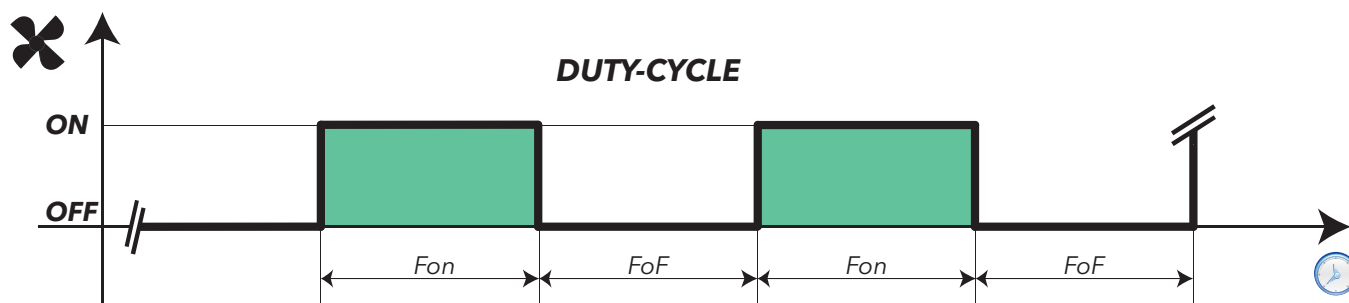



6.8.4. FAN OPERATION IN DEFROST

During defrost, the fans operate as shown in this diagram:

dFd = OFF: exclusion of fans during defrost	OFF
dFd = On: fans are not excluded during defrost (see parameters FCO , Fon , FoF)	THERMOREGULATION / DUTY CYCLE

Thermostat control of fans takes place at the values set in parameters:

- **FSt** (fans disabling temperature) and **FAd** (fans differential).

 **NOTE:** during defrost with electrical heaters, the compressor is OFF but the fans work as if the compressor was still ON, unless they have been disabled during defrost (see parameter **dFd**).

When the evaporator fans are enabled in defrost (**dFd = On**) and regulate the evaporator probe Pb2 in thermoregulated mode, when the latter enters error "E2" during defrost, the fans must always be ON, regardless of the values set via the Duty Cycle.

6.8.4.1 Fan operation without probe

If parameter **H42 = n** (probe Pb2 absent), depending on the FCO value and the status of the compressor, the fans may assume the status "On", "Off", "Duty Cycle".

The parameter **FCO** will determine the operating mode of the evaporator fans during the DAY phase and the NIGHT phase.

The following is an example of fan operation on the basis of the value set for **FCO**.

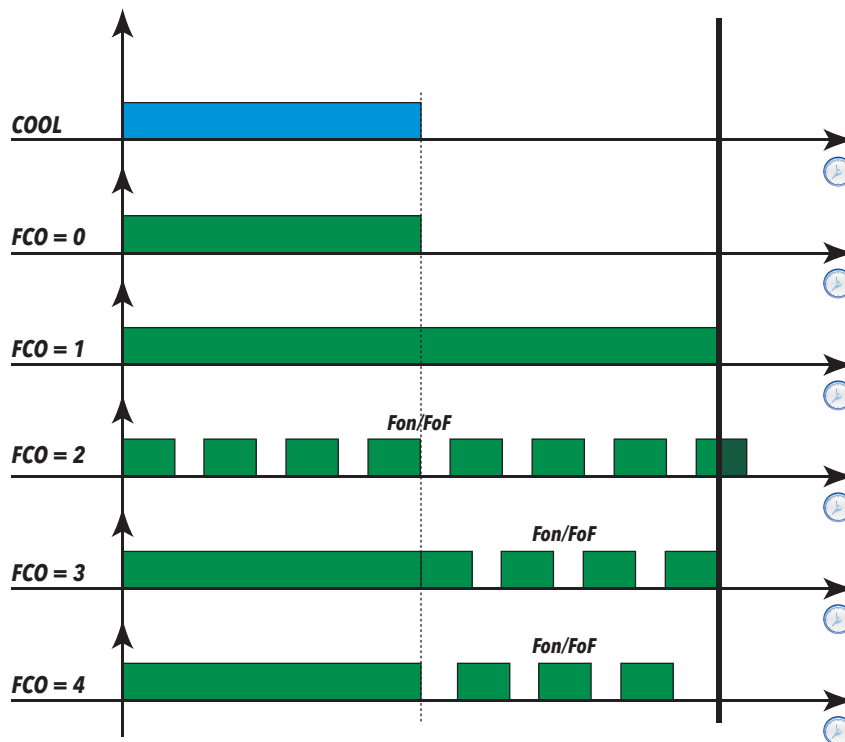



6.8.5. FAN FUNCTION DURING DRIPPING

If parameter **dt** \neq **0** (dripping time), the fans will stay OFF for the time set in this parameter.

See "**Defrost with electrical heaters**".

Note that if **Fdt** (fan delay time) is greater than **dt** (dripping time) the fans stay OFF for the time set in **Fdt** rather than **dt** (e.g. whichever timing is longer will be applied).

6.8.6. POST-VENTILATION

Parameter **FdC** delays the switching off of the fans after the compressor has stopped (increasing efficiency of the system by making better use of inertia). Post-ventilation must be active with any FCO value and without a configured probe.

If **FdC** = **0** the function is disabled.

 **NOTE:** Post-ventilation does not have priority over the delay set by parameter **dcd**.

User parameters

The parameters that manage the fan regulator are:

Label	Description
FPt	Characterises parameter "FSt" which can be expressed either as an absolute value or relative to the setpoint
FSt	Evaporator fans disabling temperature
Fdt	Evaporator fans delay after defrost cycle
dFd	Evaporator fans disabling during defrost time
FCO	Evaporator fans operating mode
FAd	Evaporator fans activation differential
dt	Dripping time
FdC	Evaporator fans switch-off delay after compressor disabled
Fon	Evaporator fans ON time in duty cycle mode
FoF	Evaporator fans OFF time in duty cycle mode



6.9. DEEP COOLING CYCLE - DCC

Description

This regulator ensures that the compressor regulates the setpoint **dCS**, with differential equal to the value set via parameter **diF**. When the **DCC** (Deep Cooling Cycle) activates, the interval between defrost cycles is cleared and defrosts disabled. Ending of the **DCC** is time-based, by setting the parameter **tdc**≠**0**, or when the setpoint **dCS** is reached if **tdc = 0**.

When a **DCC** has ended and once the time set in parameter **dcc** has elapsed, a defrost cycle is forced and the counters restart for the interval between defrost cycles (value set via parameter **dit**). If **dcc=0** defrost begins at the end of the **DCC**. During the **DCC** the temperature alarms are disabled.

Normal temperature alarm management is restored at the end of the **DCC**, when the temperature value read by probe **PB1** reaches the regulation setpoint value **SEt**.

Operating conditions

The Deep Cooling Cycle will be activated via Digital Input or via a suitably configured key.

In the event of a probe error and/or power failure, the Deep Cooling Cycle is stopped and standard controller function restored.

If parameters **dCS**, **tdc** and **dcc** are modified, the Deep Cooling Cycle is recalculated with the new values set.

 **NOTE:** After a Deep Cooling Cycle, the **dcc** time must elapse before a new cycle can begin.

The control diagram is as follows:

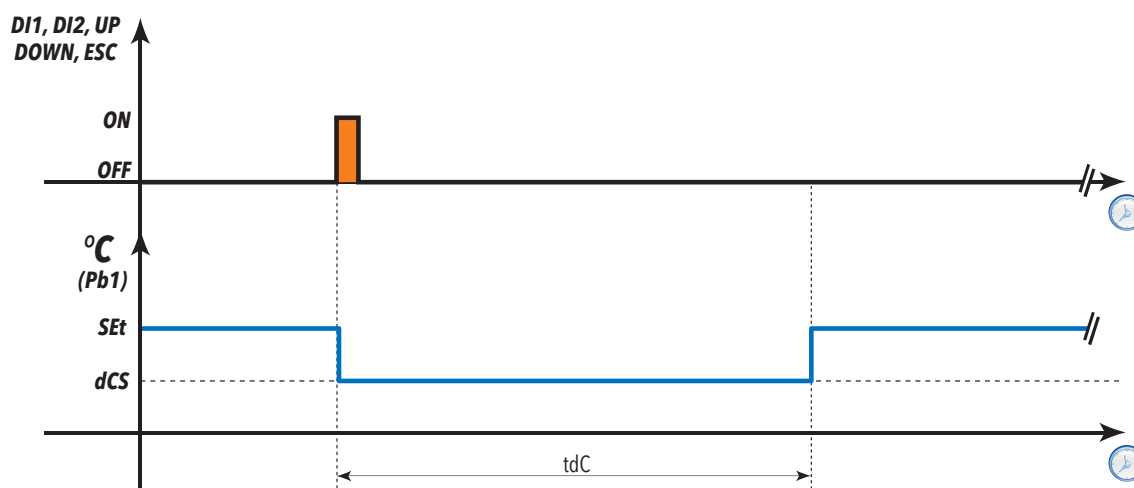

User parameters

The parameters that manage the fan regulator are:

Label	Description
dCS	Deep Cooling Setpoint
tdc	Deep Cooling Time
dcc	Defrost Delay after Deep Cooling.

6.10. PREHEAT

In the period when the preheat output is active:

- the compressor output will be forced OFF;
- the compressor LED will blink.

The Preheat only affects defrosting in applications that require the use of the compressor (**dtY**= 1 and **dtY**= 2).



6.11. PRESSURE SWITCH

Description

This regulator performs diagnostic procedures on an activated digital input by assigning the value ± 11 (General pressure switch), ± 09 (Minimum pressure switch) or ± 10 (Maximum pressure switch) to one of the parameters **H11/H12**.

If a pressure switch input is activated, power to the compressor loads is immediately cut off, the relative alarm LED lights up to provide a visual warning and the alarms folder **ALr** is also displayed. The folder contains labels with the number of pressure switch activations (up to the maximum value set in parameter **PEn**):

- **P01, P02, ...P0n...** for general pressure switch
- **H01, H02, ...H0n...** for maximum pressure switch
- **L01, L02, ...L0n...** for minimum pressure switch

If the number of activations exceeds the maximum number defined by parameter **PEn** within a time less than the value of **PEi**, the following conditions occur:

- The compressor, fan and defrost outputs are disabled.
- In the alarms folder **ALr** the label **PA, LPA** or **HPA** (general, minimum or maximum pressure switch respectively) is displayed.
- The alarm relay comes on (if configured).

- IMPORTANT:** 1) If the number of activations does not exceed the number set in **PEn** within the time limit **PEi**, the alarm is automatically cleared.
 2) The input must be:
- closed on itself if unused and the input is active when normally closed;
 - open if unused and active when normally open;
 - deactivated via digital input configuration parameter.

- NOTES:** 1) Once it has entered alarm status, the device must be switched off and on again, or reset using the **rPA** key in the functions menu.
 2) If parameter **PEn = 0**, the function is disabled and alarms and counters are also disabled.
 3) The pressure switch alarm is not stored in EEPROM.
 4) During the pressure switch activation period the defrost interval count runs as normal.

Operating conditions

The number of pressure switch errors is counted using a FIFO method. The time interval **PEi** is divided into 32 parts; the counter is incremented by one unit if there are one or more activations during one part of the entire interval **PEi**.

Two operating examples are given below: In both cases, suppose that **PEi = 32'** (equal to $32'/32 = 1$ minute) and **PEn = 7**.

Example 1: ALARM SIGNALLED.

The interval for storing activations is 1 minute: all activations within that minute are counted as a single activation and the alarm (if any) is activated when the sampling interval has elapsed. In this example the pressure switch alarm is signalled because there have been 7 activations during the 32' time window.

Example 2: ALARM NOT SIGNALLED.

In this example the alarm is not activated because during the 32' time window the number of activations set in parameter **PEn** was not reached. In practice the time window is a rolling window and all activations that are outside of it are deleted: the reference point is the last activation and the time **PEi** is subtracted from that point to establish how many activations are included in the count.



User parameters

The parameters that manage the pressure switch regulator are:

Label	Description
PEn	Number of errors allowed per general/maximum/minimum pressure switch input
PEI	General/minimum/maximum pressure switch error count interval (in 32 parts)



6.11.1. AUXILIARY OUTPUT (AUX/LIGHT)

Description

If one of the parameters **H21...H25** is set to the value **H2x=5**, it anticipates the relay control as AUX and, by pressing the associated key **H32...H35** - which should be set to the value **H3x=3**, the relay is activated if it was off previously and vice-versa.

The on/off status is saved in non-volatile memory hence when power returns after a blackout, the device will restart in the status that was active prior to the blackout.

If one of the parameters **H11...H12** is set to the value **H11, H12=3**, it anticipates the AUX relay control by the digital input; in this case the relay will mirror the status of the input. In this case, on/off status is not saved in non-volatile memory.



IMPORTANT: the meaning of the D.I. must always remain the same: for example, if the relay is activated by D.I. and switched off by key, when the D.I. is reset to the starting position, the relay does not change status (since it was already de-energised by key). With the instrument OFF, if set accordingly, only the digital input (D.I.) and the associated key can change the status of the output.

Operating conditions

The regulator is activated by:

- Key
- Function
- Digital input

if configured accordingly.

The regulator is not active when:

Condition	AUX output status	NOTES
during start-up	OFF	
during stand-by	status depending on parameter H08	

The control diagram is as follows:

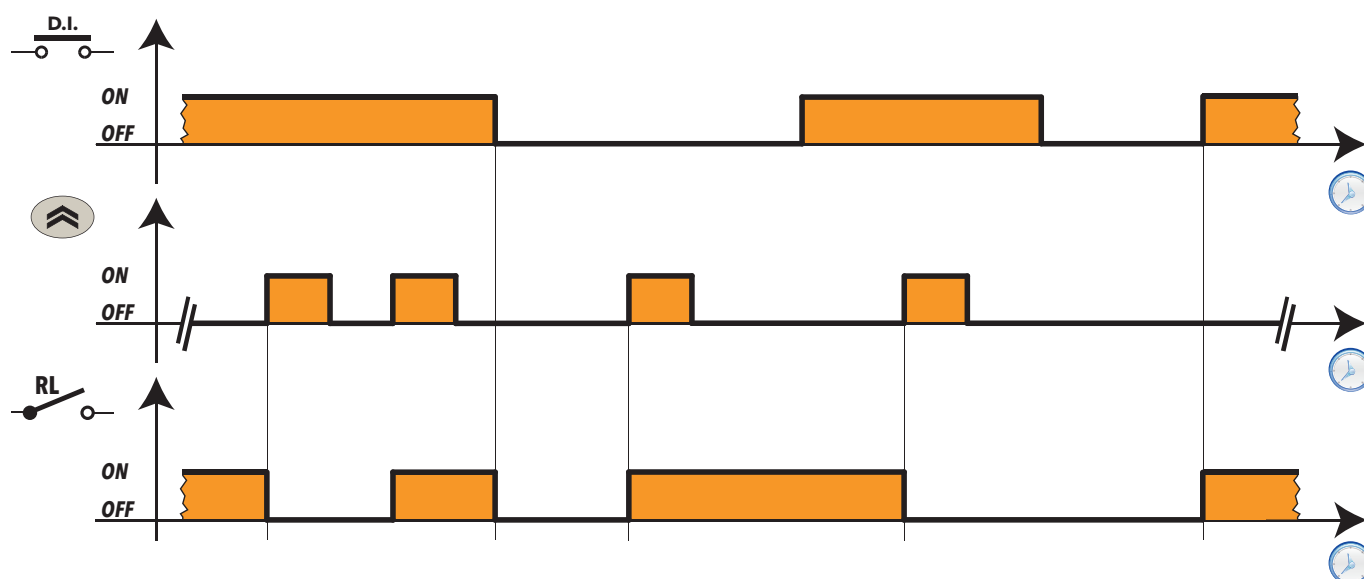

User parameters

The parameters that manage the auxiliary (AUX) output regulator are:

Label	Description
H11...H12	Configuration of digital input 1...2 / Polarity
H21...H25	Configuration of digital output 1...5
H32...H35	Configuration of DOWN, ESC, ON/OFF, LIGHT key



6.12. DOOR/EXTERNAL ALARM MANAGEMENT

The door switch input is associated to an appropriately configured digital input (**H1x = ±4**).

By controlling the opening of the door, it is possible to deactivate the compressor output and/or the fans.

It is also possible to associate a deactivation delay to the compressor output by means of parameter **dCO**.

If the door is opened during a defrost cycle, the cycle is not shut down.

The values that can be set for the parameters involved are:

dod: Door switch switches off loads on D.I. command.

- **0** = function disabled
- **1** = disables fans (FAN)
- **2** = disables the compressor (COMP)
- **3** = disables the compressor (COMP) and fans (FAN)

Any protective timers (e.g. compressor start delay, etc.) will still be observed.

rLO: Locks compressor, defrost and fan regulators if the digital input (configured as external alarm) is activated.

- **0** = no resource locked
- **1** = compressor and defrost locked
- **2** = compressor, defrost and fans locked

dOA: Establishes what should be activated/deactivated on activation/deactivation of the digital input. Only applies if **PEA** ≠ 0.

- **0** = activates the compressor (COMP)
- **1** = activates fans (FAN)
- **2** = activates the compressor (COMP) and fans (FAN)
- **3** = deactivates the compressor (COMP)
- **4** = deactivates fans (FAN)
- **5** = deactivates the compressor (COMP) and fans (FAN)

PEA: Establishes which of the door switch and alarm should be linked to the parameter **dOA** in the following way:

- **0** = function deactivated
- **1** = function linked to door switch
- **2** = function linked to external alarm
- **3** = function linked to door switch and external alarm



dCO: Compressor resource activation/power off delay (0 ... 255 min).

dFO: Evaporator Fan resource activation/power off delay (0 ... 255 min).

tdO: Door open alarm exclusion time (0 ... 255 min). The door open alarm will be activated if the door remains open for a time period greater than the setting for this parameter.

The way in which parameters **dCO** and **dFO** act depends on how the parameter **dOA** is configured. To better understand the meaning of these parameters, refer to the figures below.

The graphs below illustrate fan operation on the basis of the **dOA** value. In the graphs, we can see that:

	Door
	Evaporator fans
	Compressor

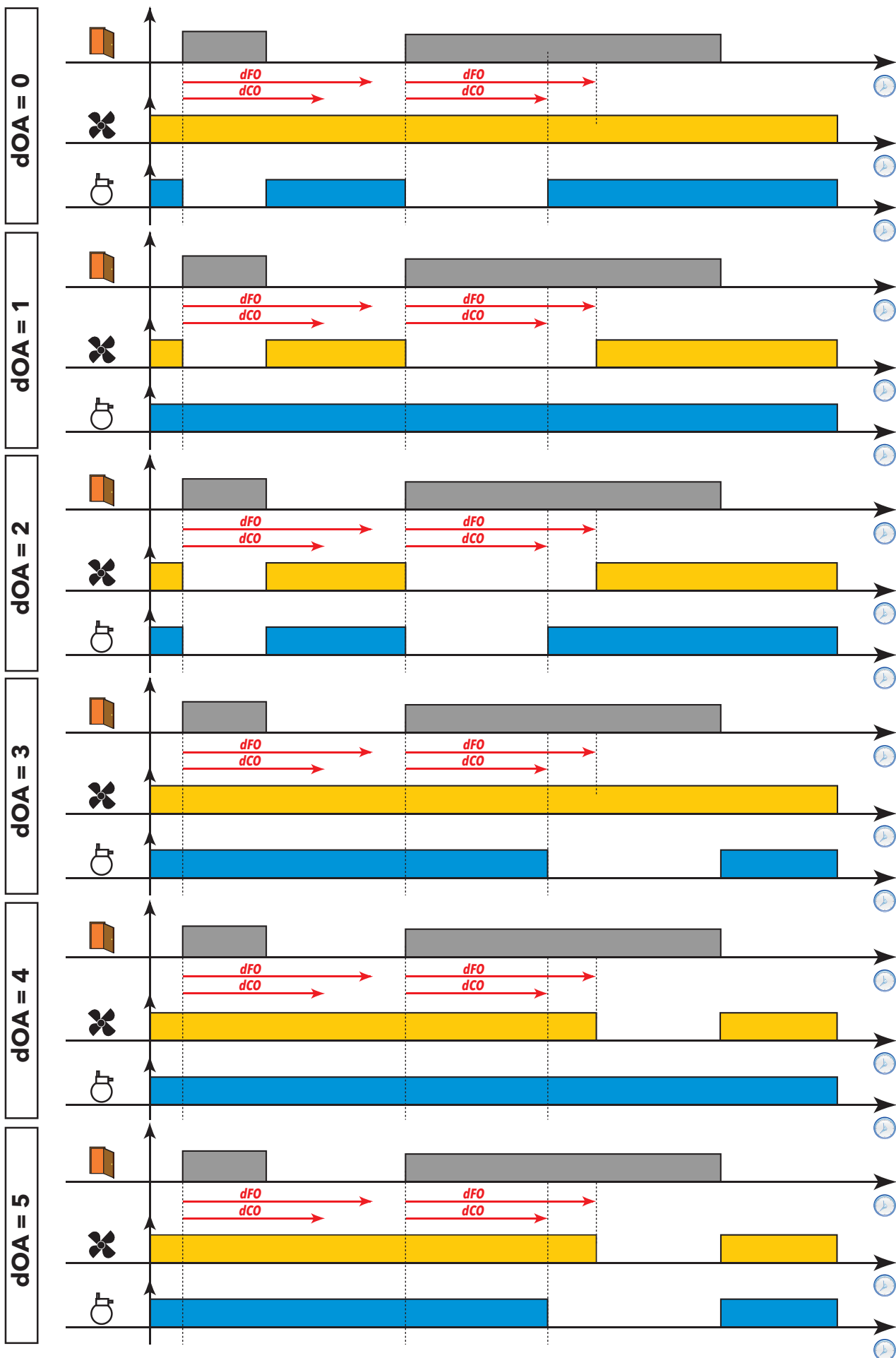



6.13. DEMISTING HEATERS (FRAME HEATERS)

The controller is equipped with a regulator for the frame heaters.

Description

Operating conditions

The table below lists the ways the relay output can be managed:

HOn	HOF	FRAME HEATER OUT
0	0	OFF
0	>0	OFF
>0	0	ON
>0	>0	DUTY CYCLE

If **HOn** > 0 and **HOF** = 0, the regulator is off.

If **HOn** > 0 and **HOF** > 0, the regulator activates in operating cycle mode irrespective of the values read by the probes (cold room probe failure) and of requests from other loads (**Duty Cycle** mode).

If the cold room probe is working properly, the Duty Cycle mode does **NOT** activate as it does not have priority over normal regulator settings.

The following diagram shows the **Duty Cycle** operating mode based on parameters **HOn** and **HOF** > 0:

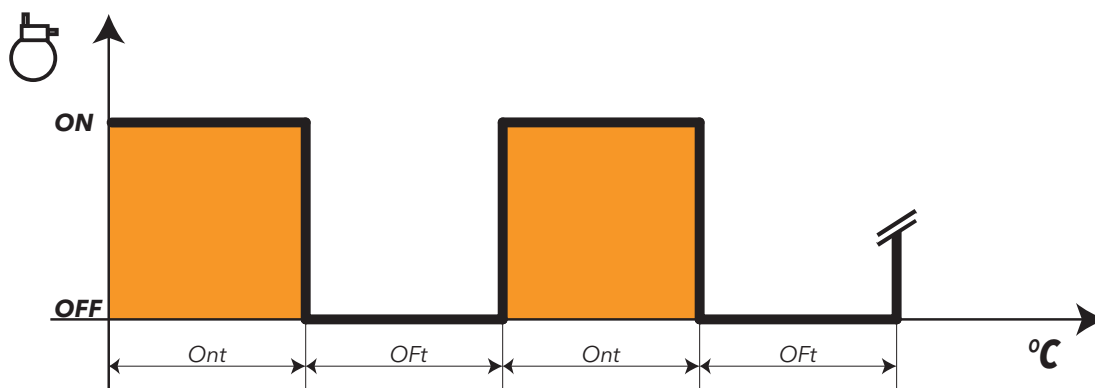

User parameters

The parameters that manage the frame heater regulator are:

Label	Description
HOn	Frame Heater regulator output ON time.
HOF	Frame Heater regulator output OFF time.
dt3	Frame Heater regulator time standard unit of measurement: 0=hours; 1=minutes; 2=seconds



6.14. CONDENSER FANS

This regulator is associated with probe Pb3 (see specific section) and features:

- SCF activation setpoint
- dCF operating differential
- dCd exclusion of fans during defrost
- tCF activation delay after end of defrost

If a digital output is set as condenser fans (H21...H25=12), this output will behave as follows:

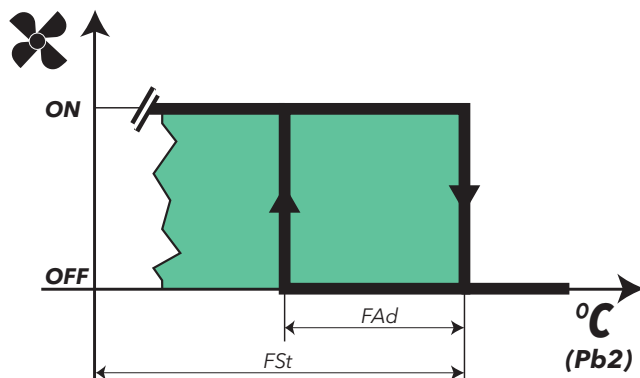

If probe Pb3 is not present and if alarm E3 is active, the regulator will always be active except during the defrost cycle.

Probe 3 can be excluded and, in this case, its lack of connection to the instrument will not cause any error signalling to occur.

NOTE: During the dripping time the output is OFF.

NOTE: If a digital output is programmed as "condenser fans" (H21...H25=12), parameter SA3 is always an absolute value, regardless of the value assumed by the parameter Att.

User parameters

The parameters that manage the condenser fan regulator are:

Label	Description
SCF	Condenser fans activation Setpoint
dCF	Condenser fans activation differential
tCF	Condenser fans switch-on delay after defrost
dCd	Exclusion of condenser fans during defrost
dt	Dripping time.



6.15. STAND-BY

Operating conditions

The stand-by regulator can be activated by digital input (if configured) or by key (if programmed).

With the device OFF the display shows "OFF" and all regulators are blocked including alarms.

When the device is switched on via a key or an appropriately configured digital input, regular operation commences, the same as from power-on. After power-on, the temperature alarm is excluded for a time set in parameter **PAO**, and the delay set by parameter **OdO** is activated.

Each time that the device is switched off, all cycle times are reset.

The on/off status is saved in non-volatile memory hence when power returns after a blackout, the device will restart in the status that was active prior to the blackout.

The output from stand-by is linked to the delay set in parameter **OdO**.



NOTE: With the controller off, all relays are de-energized except for Aux: button/aux input-light-door switch are active.

User parameters

The parameters that manage the stand-by regulator are:

Label	Description
PAO	Alarm disabling after power-on
OdO	Output activation delay from power-on
OAO	High/low temperature alarm exclusion time after door closing

6.16. PUMP DOWN

In some applications, Coldface manages the fluid solenoid valve, located in the cold room, while the refrigeration output is generated by a condenser unit, where the compressor is switched on/off directly by a minimum pressure switch on the unit itself. Pump-down mode can be used to manage the compressor directly by connecting the minimum pressure switch to the Coldface, which means it can also be used for diagnostics.

The purpose of this regulator is to allow compressor activation (pump-down compressor output) exclusively on the basis of minimum pressure switch regulation and regardless of the status of the main temperature controller, which will be used to activate/deactivate solenoid valves (compressor output) instead.

6.16.1. SERVICE STOPPAGE

Service stoppage switches the cold room OFF, and this status is indicated on the display. It also allows compressor activation every time the pressure on the suction line rises until the minimum pressure switch starts running (pump-down).

7. PARAMETERS



7.1. HOW TO MODIFY THE USER PARAMETERS

The 'User' parameters are the most useful parameters and are described in this document, in the section Parameters Table.

- 1) Press and hold the SET key for 3 seconds until the display shows USr
- 2) Press and release the SET key once more. The upper display will show the first parameter, the lower display will indicate the current parameter value
- 3) Using the UP & DOWN keys, find the parameter that you wish to modify
- 4) Press and release the SET key once more. The upper display will show the name of the blinking parameter
- 5) Use the UP & DOWN keys to adjust the parameter value
- 6) Press and release SET to save the parameter value
- 7) Return to step 3) or press ESC several times to return to the normal display

THE INSTRUMENT IS USED TO EDIT OTHER PARAMETERS PRESENT IN THE INSTALLER LEVEL (inS)

7.2. HOW TO EDIT THE INSTALLER LEVEL PARAMETERS

- 1) Press and hold the SET key for 3 seconds until the display shows **USr**
 - 2) Use UP & DOWN to select the parameter section **inS**
 - 3) Press and release the SET key once more. The display will show the first folder
 - 4) Press and release the SET key once more. The upper display will show the first parameter in the folder, the lower display will indicate the current parameter value
 - 5) Using the UP & DOWN keys, find the parameter that you wish to modify
- The procedure proceeds in a similar manner to that described for the User parameters (points 4-7)



7.3. PARAMETER TABLE

PAR.	LEV.	DESCRIPTION	U.M.	RANGE	DEFAULT
SEt	USr/inS	Temperature control SEtpoint	°C/°F	-58.0...302	0.0
COMPRESSOR (CPr)					
diF	USr/inS	Activation differential (absolute or relative). N.B.: diF cannot be equal to 0.	°C/°F	0 ... 30.0	2.0
HSE	USr/inS	Maximum value that can be assigned to the setpoint. NOTE: The two setpoints are interdependent: HSE cannot be less than LSE and vice-versa.	°C/°F	LSE ... HdL	50.0
LSE	USr/inS	Minimum value that can be assigned to the setpoint. NOTE: The two setpoints are interdependent: LSE cannot be greater than HSE and vice-versa.	°C/°F	LdL ... HSE	-50.0
OSP	USr/inS	Temperature value to be added algebraically to the setpoint if reduced set enabled (Economy function). Enabling can take place via key, function or digital input configured specifically for this purpose.	°C/°F	-30.0 ... 30.0	0.0
Cit	USr/inS	Minimum activation time of compressor before possible deactivation. If Cit = 0 not active.	min	0 ... 255	0
CAt	USr/inS	Maximum activation time of compressor before possible deactivation. If CAt = 0 not active.	min	0 ... 255	0
Ont	USr/inS	Controller switch-on time in the event of faulty probe. - if Ont = 1 and OFt = 0 , compressor stays on permanently (ON). - if Ont > 0 and OFt > 0 , compressor operates in Duty Cycle mode.	min	0 ... 255	10
OFt	USr/inS	Controller switch-off time in the event of faulty probe. - if OFt = 1 and Ont = 0 , compressor will always stay off (OFF). - if Ont > 0 and OFt > 0 , compressor operates in Duty Cycle mode.	min	0 ... 255	10
dOn	USr/inS	Delayed start. The parameter indicates that a protection is active on the general compressor relay actuations. At least the indicated time must elapse between the request and the actual activation of the compressor relay.	sec	0 ... 255	2
dOF	USr/inS	Delay time after power-off: the delay time indicated must elapse between deactivation of the compressor relay and the next power-on.	min	0 ... 255	0
dbi	USr/inS	Delay between switch-ons; the delay time indicated must elapse between two consecutive compressor power-ons.	min	0 ... 255	2
OdO	USr/inS	Output activation delay after the instrument is switched on or after a power failure. 0 = not active	min	0 ... 255	0
dSC	inS	Compressor 2 activation delay. Indicates the time after which the relay configured as compressor 2 will be activated in relation to the first compressor. If compressor 1 is disabled during this time, the call for compressor 2 will be cancelled.	sec	0 ... 255	0
dCS	inS	DEEP COOLING CYCLE Deep cooling cycle setpoint.	°C/°F	-302.0 ... 1472.0	0
tdc	inS	Deep cooling cycle duration.	min	0 ... 600	10
dcc	inS	Defrost delay after deep cooling cycle.	min	0 ... 255	0
DEFROST (dEF)					
dtY	USr/inS	Defrost mode. 0 = electric defrost (using heaters). 1 = inverse cycle defrost. 2 = hot gas defrost for plug-in applications (with integrated compressor). 3 = hot gas defrost for applications with remote control (e.g.. remote cabinets).	num	0 ... 2	0
dit	USr/inS	Interval between defrost cycles. Interval between the start of two consecutive defrost cycles. 0 = function disabled (defrost NEVER performed).	hours/mins/ secs	0 ... 255	6 hours
dt1	inS	Unit of measurement for defrost interval (parameter dit). 0 = parameter dit in hours. 1 = parameter dit in minutes. 2 = parameter dit in seconds.	num	0 ... 2	0
dt2	inS	Unit of measurement for duration of defrost (parameter dEt/dE2). 0 = parameter dEt/dE2 in hours. 1 = parameter dEt/dE2 in minutes. 2 = parameter dEt/dE2 in seconds.	num	0 ... 2	1



PAR.	LEV.	DESCRIPTION	U.M.	RANGE	DEFAULT		
dCt	USr/inS	Defrost interval count mode. 0 = compressor running time (DIGIFROST® method); defrost active ONLY when compressor is on. NOTE: compressor running time is counted separately from the evaporator probe (count active also when evaporator probe missing or faulty). 1 = appliance running time; defrost counting is always active when the machine is on and starts at each power-on. 2 = compressor stop. Every time the compressor stops, a defrost cycle is performed according to parameter dtY. 3 = RTC. Defrost at specific times set by parameters dE1...dE8, F1...F8.	num	0 ... 3	1		
dOH	USr/inS	Defrost cycle activation delay from request. Delay preceding start of first defrost after call.	min	0 ... 59	0		
dEt	USr/inS	Defrost timeout. Determines the maximum defrost time on Evaporator 1.	hours/mins/secs	1 ... 255	30		
dSt	USr/inS	Defrost end temperature. Defrost 1 end temperature (determined by evaporator probe 1).	°C/°F	-302.0 ... 1472.0	6.0		
dS2	inS	Evaporator 2 defrost end temperature. Determines the maximum defrost time on Evaporator 2.	°C/°F	-302.0 ... 1472.0	8.0		
dE2	inS	Evaporator 2 maximum defrost duration. Determines the maximum defrost time on Evaporator 2.	hours/mins/secs	1 ... 255	30		
dPO	USr/inS	Defrost enabling request from power-on. Determines whether or not the instrument must defrost at power-up (provided that the temperature measured at the evaporator will allow defrost). n = no, does not start defrosting at power-on; y = yes, starts defrost at power-on.	flag	n/y	n		
tcd	inS	Compressor output activation/deactivation time before a defrost. Minimum time that must elapse with the compressor ON or OFF before defrost is activated.	min	-31 ... 31	0		
Cod	inS	Time preceding a defrost, during which the compressor output is not activated.	min	0 ... 60	0		
Parameters dE1...dE8 / F1...F8 - ONLY VISIBLE IN HACCP MODELS Important: do not confuse parameters dE1...dE8 with values d0 ...d7 in folder nAd, used for the Day/Night regulator.							
dE1...dE8 F1...F8		Parameters for setting the time of single defrosts. <ul style="list-style-type: none"> • daily (dE1...dE8) • daily "weekends/public holidays" (F1...F8), used by the Day/Night regulator. The parameters will only be displayed if: <ul style="list-style-type: none"> • dit = 0 • dCt = 3 (Real time clock) • H48 = y (rtc option declared present) • the device has been switched off and on again after the above parameters have been set. 					
dE1...dE8		Setting the time for defrosts on weekdays If parameter dit (defrosting interval) = 0, dCt = 3 and the rtc option is (declared) present, then parameters dE1...dE8 allow you to set the hours and minutes. Only on the basis of these values will a defrost cycle begin. If you do not wish to use some of the defrost times (dE1...dE8), exclude them as explained below: Select the parameter (dE1...dE8) that you want to exclude, then increase the value until 24 appears on the display, indicating that the parameter has been excluded. Bear in mind that the times do not have to be set in exact chronological order, e.g. dE1 = h 12.25 dE2 = h 06.05 dE3 = h 18.30 ...	hours and minutes		The parameter is then split into dEn_H (hours), dEn_m (minutes), n=1...8		
F1...F8		Setting the time for defrosts on weekends/public holidays If parameter dit (defrosting interval) is dit = 0, dCt = 3 and the RTC option is declared present, then parameters F1...F8 allow you to set the hours and minutes. Only on the basis of these values will a defrost cycle begin. If you do not wish to use some of the defrost times (F1...F8), exclude them as explained below: Select the parameter (F1...F8) that you want to exclude, then increase the value until 59 appears on the display, indicating that the parameter has been excluded. Bear in mind that the times do not have to be set in exact chronological order, e.g. • F1 = h 12.25 • F2 = h 06.05 • F3 = h 18.30	hours and minutes		The parameter is then split into Fn_H (hours), Fn_m (minutes), n=1...8		
dE1H	USr/inS	Start time weekday defrost 1.		0 ... 23 = start hour; 24 = disabled.	hours	0 ... 24	0
dE1m	USr/inS	Start time minutes weekday defrost 1.			min	0 ... 59	0
dE2H	USr/inS	Start time weekday defrost 2.		d1H ... 23 = start hour; 24 = disabled.	hours	0 ... 24	0



PAR.	LEV.	DESCRIPTION	U.M.	RANGE	DEFAULT																								
dE2m	USr/inS	Start time minutes weekday defrost 2.	min	0 ... 59	0																								
dE3H	USr/inS	Start time weekday defrost 3. d2H ... 23 = start hour; 24 = disabled.	hours	0 ... 24	0																								
dE3m	USr/inS	Start time minutes weekday defrost 3.	min	0 ... 59	0																								
dE4H	USr/inS	Start time weekday defrost 4. d3H ... 23 = start hour; 24 = disabled.	hours	0 ... 24	0																								
dE4m	USr/inS	Start time minutes weekday defrost 4.	min	0 ... 59	0																								
dE5H	USr/inS	Start time weekday defrost 5. d4H ... 23 = start hour; 24 = disabled.	hours	0 ... 24	0																								
dE5m	USr/inS	Start time minutes weekday defrost 5.	min	0 ... 59	0																								
dE6H	USr/inS	Start time weekday defrost 6. d5H ... 23 = start hour; 24 = disabled.	hours	0 ... 24	0																								
dE6m	USr/inS	Start time minutes weekday defrost 6.	min	0 ... 59	0																								
dE7H	USr/inS	Start time weekday defrost 7. d4H ... 23 = start hour; 24 = disabled.	hours	0 ... 24	0																								
dE7m	USr/inS	Start time minutes weekday defrost 7.	min	0 ... 59	0																								
dE8H	USr/inS	Start time weekday defrost 8. d5H ... 23 = start hour; 24 = disabled.	hours	0 ... 24	0																								
dE8m	USr/inS	Start time minutes weekday defrost 8.	min	0 ... 59	0																								
F1H	USr/inS	Start time weekend/public holiday defrost 1. 0 ... 23 = start hour; 24 = disabled.	hours	0 ... 24	0																								
F1m	USr/inS	Start time minutes weekend/public holiday defrost 1.	min	0 ... 59	0																								
F2H	USr/inS	Start time weekend/public holiday defrost 2. F1H ... 23 = start hour; 24 = disabled.	hours	0 ... 24	0																								
F2m	USr/inS	Start time minutes weekend/public holiday defrost 2.	min	0 ... 59	0																								
F3H	USr/inS	Start time weekend/public holiday defrost 3. F2H ... 23 = start hour; 24 = disabled.	hours	0 ... 24	0																								
F3m	USr/inS	Start time minutes weekend/public holiday defrost 3.	min	0 ... 59	0																								
F4H	USr/inS	Start time weekend/public holiday defrost 4. F3H ... 23 = start hour; 24 = disabled.	hours	0 ... 24	0																								
F4m	USr/inS	Start time minutes weekend/public holiday defrost 4.	min	0 ... 59	0																								
F5H	USr/inS	Start time weekend/public holiday defrost 5. F4H ... 23 = start hour; 24 = disabled.	hours	0 ... 24	0																								
F5m	USr/inS	Start time minutes weekend/public holiday defrost 5.	min	0 ... 59	0																								
F6H	USr/inS	Start time weekend/public holiday defrost 6. F5H ... 23 = start hour; 24 = disabled.	hours	0 ... 24	0																								
F6m	USr/inS	Start time minutes weekend/public holiday defrost 6.	min	0 ... 59	0																								
F7H	USr/inS	Start time weekend/public holiday defrost 7. F5H ... 23 = start hour; 24 = disabled.	hours	0 ... 24	0																								
F7m	USr/inS	Start time minutes weekend/public holiday defrost 7.	min	0 ... 59	0																								
F8H	USr/inS	Start time weekend/public holiday defrost 8. F5H ... 23 = start hour; 24 = disabled.	hours	0 ... 24	0																								
F8m	USr/inS	Start time minutes weekend/public holiday defrost 8.	min	0 ... 59	0																								
FANS (FAn)																													
FpT	inS	FSt parameter management mode. (0) = absolute value; (1) = relative value.	flag	0/1	0																								
FSt	USr/inS	Fans lockout temperature; if the value read is greater than FSt, the fans will be stopped. The value can positive or negative.	°C/°F	-58.0...302	6.0																								
Fot	inS	Fans start temperature. If the temperature read by the evaporator probe is lower than the set value, the fans remain off.	°C/°F	-58.0...302	-50.0																								
FAd	USr/inS	Fans activation differential.	°C/°F	0.1 ... 25.0	1.0																								
Fdt	USr/inS	Fans activation delay after a defrost cycle.	min	0 ... 255	0																								
dt	USr/inS	Dripping time. Dripping time.	min	0 ... 255	0																								
dFd	USr/inS	Operating mode of evaporator fans during defrost. n (0) = Fans Off; y (1) = Fans On.	flag	n/y	y																								
FcO	USr/inS	Evaporator fans operating mode. The status of the fans will be: <table border="1" data-bbox="363 1550 1062 1917"> <thead> <tr> <th>FCO</th> <th>COMPRESSOR ON</th> <th>COMPRESSOR OFF</th> <th>Notes</th> </tr> </thead> <tbody> <tr> <td>0</td> <td>Thermostat controlled</td> <td>OFF</td> <td>-</td> </tr> <tr> <td>1</td> <td>Thermostat controlled</td> <td>Thermostat controlled</td> <td>-</td> </tr> <tr> <td>2</td> <td>Thermostat controlled</td> <td>Thermostat controlled</td> <td>-</td> </tr> <tr> <td>3</td> <td>Thermostat controlled</td> <td>Duty cycle</td> <td>controlled via parameters FOn and FOF</td> </tr> <tr> <td>4</td> <td>Thermostat controlled</td> <td>Duty cycle</td> <td>controlled via parameters FOn and FOF</td> </tr> </tbody> </table>	FCO	COMPRESSOR ON	COMPRESSOR OFF	Notes	0	Thermostat controlled	OFF	-	1	Thermostat controlled	Thermostat controlled	-	2	Thermostat controlled	Thermostat controlled	-	3	Thermostat controlled	Duty cycle	controlled via parameters FOn and FOF	4	Thermostat controlled	Duty cycle	controlled via parameters FOn and FOF	num	0 ... 4	1
FCO	COMPRESSOR ON	COMPRESSOR OFF	Notes																										
0	Thermostat controlled	OFF	-																										
1	Thermostat controlled	Thermostat controlled	-																										
2	Thermostat controlled	Thermostat controlled	-																										
3	Thermostat controlled	Duty cycle	controlled via parameters FOn and FOF																										
4	Thermostat controlled	Duty cycle	controlled via parameters FOn and FOF																										
FdC	inS	Evaporator fans switch-off delay after compressor deactivation.	min	0 ... 255	0																								
FOn	inS	Time fans remain ON during daytime duty cycle. Fans used in duty cycle mode; applies to FCO = 3,4 (duty cycle) .	min	0 ... 255	0																								
FOF	inS	Time fans remain OFF during daytime duty cycle. Fans used in duty cycle mode; applies to FCO = dc .	min	0 ... 255	0																								



PAR.	LEV.	DESCRIPTION	U.M.	RANGE	DEFAULT
SCF	inS	Condenser Fans Condenser fans activation Setpoint	°C/°F	-50.0...150.0	10.0
dCF	inS	Condenser fans activation differential	°C/°F	-30.0...30.0	2.0
tCF	inS	Condenser fans switch-on delay after defrost	min	0...59	0
dCd	inS	Exclusion of condenser fans during defrost. n (0) = fans running during defrost; y (1) = fans excluded.	flag	n/y	n
ALARMS (ALr)					
Att	inS	Parameters HAL and LAL mode intended as the absolute temperature value or differential in relation to the Setpoint. (0) = absolute value (1) = relative value NOTE: In case of relative values (par. Att=1), the HAL parameter should be set to positive values, while the LAL parameter should be set to negative values (-LAL).	flag	0/1	0
AFd	USr/inS	Alarms cut-in differential.	°C/°F	0.1 ... 25.0	1.0
HAL	USr/inS	Probe 1 maximum alarm. Temperature value (intended either as distance from setpoint or as an absolute value based on Att) above which the probe will trigger activation of the alarm signal.	°C/°F	LA1...302	50.0
LAL	USr/inS	Probe 1 minimum alarm Temperature value (intended as distance from setpoint or as an absolute value based on Att) beneath which the probe will trigger activation of the alarm signal.	°C/°F	-58.0...HA1	-50.0
PAO	USr/inS	Alarm exclusion time after device is switched on following a power failure. This parameter refers to high/low temperature alarms LAL and HAL only.	hours	0 ... 10	3
dAO	USr/inS	Temperature alarm exclusion time after defrost.	min	0 ... 255	60
OAO	USr/inS	Alarm indication delay (high and low temperature) following deactivation of digital input (port closed).	hours	0 ... 10	1
tdO	USr/inS	Door open alarm activation delay.	min	0 ... 255	10
tAO	USr/inS	Delay preceding temperature alarm signal. This parameter refers to high/low temperature alarms LAL and HAL only.	min	0 ... 255	0
dAt	inS	Alarm indicating end of defrost as a result of timeout. n (0) = the alarm is not triggered. y (1) = triggers the alarm.	flag	n/y	n
rLO	inS	Regulators inhibited by external alarm. 0 = does not inhibit any resource. 1 = compressor and defrost blocked. 2 = compressor, defrost and fans blocked.	num	0/1/2	0
AOP	inS	Alarm output polarity: 0 = alarm active and output disabled. 1 = alarm active and output enabled.	flag	0 ... 1	1
PbA	inS	Configuration of temperature alarm on probe 1 and/or 3: 0 = on probe 1 (cold room). 1 = on probe 3 (display). 2 = on probes 1 and 3 (cold room and display). 3 = on probes 1 and 3 (cold room and display) with external threshold.	num	0 ... 3	0
SA3	inS	Probe 3 alarm setpoint.	°C/°F	-302.0 ... 1472.0	0.0
dA3	inS	Probe 3 alarm differential.	°C/°F	-300 ... 300	2.0
tA3	inS	Delay time for alarm signal on probe 3.	min	0 ... 59	0
ArE	inS	Enables alarm relay in the event of probe 3-related alarms: 0 = does not enable alarms in the event of alarms/errors on probe 3. 1 = enables the alarm relay in the event of alarms/errors on all probes. 2 = enables the alarm relay ONLY in the event of alarms/errors on probe 3.	num	0 ... 2	0
LIGHTS & DIGITAL INPUTS (Lit)					
dSd	inS	Light relay / door switch interlock. n (0) = door opening does not switch on the light. y (1) = door opening switches on the light (if it was off).	flag	n/y	y
dLt	inS	Delay preceding deactivation (switch-off) of light relay (interior light). The interior light remains on for dLt minutes when the door is closed if parameter dSd is set to 'yes'.	min	0 ... 31	0
OFL	inS	Light relay always deactivated by light key. Allows the interior light to be switched off by pressing the key, even if the delay parameter dLt is set to 'yes'. n (0) = no. y (1) = yes.	flag	n/y	y
dOd	inS	Enable switch-off of loads on activation of door switch. 0 = disabled. 1 = disable fans. 2 = disable compressor. 3 = disable fans and compressor.	num	0 ... 3	1



PAR.	LEV.	DESCRIPTION	U.M.	RANGE	DEFAULT
dAd	inS	Activation delay for digital inputs DI1, DI2.	min	0 ... 255	0
dOA	inS	Action forced from digital input (if PEA ≠ 0): 0 = activate compressor. 1 = activate fans. 2 = activate compressor and fans. 3 = deactivate compressor. 4 = deactivate fans. 5 = deactivate compressor and fans.	num	0 ... 5	0
PEA	inS	Selection of digital input configured to inhibit/enable resources. 0 = function disabled. 1 = associated with door switch. 2 = associated with external alarm. 3 = associated with external alarm and door switch.	num	0 ... 3	0
dCO	inS	Compressor activation/deactivation delay when enabled.	min	0 ... 255	0
dOC	inS	Compressor switch-off delay from acknowledgement.	min	0 ... 255	0
dFO	inS	Fan activation/deactivation delay when enabled.	min	0 ... 255	0
PEn	inS	Number of errors allowed per pressure switch input. 0 = disabled.	num	0 ... 15	15
PEi	inS	Pressure switch error count interval.	min	1 ... 99	99

**NIGHT AND DAY (nAd)
FOLDER ONLY VISIBLE IN HACCP MODELS**

If the Night & Day regulator is enabled (via key or D.I.), both weekday and weekend defrost management is active (see parameters dE1...dE8, F1...F8): parameter E3 can be used for every day to establish which defrosts to activate.

If the Night & Day regulator has not been enabled, only weekday defrosts dE1...dE8 will be run.

Folder consisting of 7 sub-folders: d0, d1, d2, d3, d4, d5, d6 and d7*, each of which contain the following parameters.

NOTE: it is advisable to consider the first day d0 as SUNDAY. 'd7' can be used to program daily events which are valid for all days.

E0		Functions enabled during events. 0 = events management disabled. 1 = enable reduced setpoint. 2 = enable reduced set+light. 3 = enable reduced set+light+aux. 4 = enable stand-by. 5 = enable reduced setpoint*. 6 = enable reduced set+light*. 7 = enable reduced set+light+aux*. 8 = enable stand-by*. * disables the buzzer; the alarms and alarm relay continue to run as per the programming.			
E1		Start of event hours/minutes. Sets event start time based on the value of E0. The "NIGHT" mode begins at this time. The duration is determined by parameter E2. In hours and minutes (in the parameter table, the parameter is split into E1_h (hours), E1_min (minutes)).			
E2		Duration of event. Sets the duration of the event starting as programmed in E1, based on the value of E0. In hours.			
E3		Enable defrost weekdays or weekends: 0 = "weekdays" defrost sequence defined by parameters dE1...dE8. 1 = "weekends/public holidays" defrost sequence defined by parameters F1...F8. NOTE: This regulator can be enabled by key (see para. H32...H37=11) or by Digital Input (see para. H11...H12=16). Note: for the daily event 'd7', this parameter is ignored (it is not possible to manage defrosts).			
d0_E00	inS	Enable functions during events day 1.	num	0 ... 8	0
d0_E01_h	inS	Event start time (hours) day 1.	hours	0 ... 23	0
d0_E01_min	inS	Event start time (minutes) day 1.	min	0 ... 59	0
d0_E02	inS	Event duration day 1.	hours	0 ... 72	0
d0_E03	inS	Enable defrost weekdays or weekends day 1.	flag	0 ... 1	0
d1_E00	inS	Enable functions during events day 2.	num	0 ... 8	0
d1_E01_h	inS	Event start time (hours) day 2.	hours	0 ... 23	0
d1_E01_min	inS	Event start time (minutes) day 2	min	0 ... 59	0
d1_E02	inS	Event duration day 2.	hours	0 ... 72	0
d1_E03	inS	Enable defrost weekdays or weekends day 2	flag	0 ... 1	0
d2_E00	inS	Enable functions during events day 3.	num	0 ... 8	0
d2_E01_h	inS	Event start time (hours) day 3.	hours	0 ... 23	0
d2_E01_min	inS	Event start time (minutes) day 3.	min	0 ... 59	0
d2_E02	inS	Event duration day 3.	hours	0 ... 72	0
d2_E03	inS	Enable defrost weekdays or weekends day 3.	flag	0 ... 1	0
d3_E00	inS	Enable functions during events day 4.	num	0 ... 8	0
d3_E01_h	inS	Event start time (hours) day 4.	hours	0 ... 23	0
d3_E01_min	inS	Event start time (minutes) day 4.	min	0 ... 59	0
d3_E02	inS	Event duration day 4.	hours	0 ... 72	0
d3_E03	inS	Enable defrost weekdays or weekends day 4.	flag	0 ... 1	0



PAR.	LEV.	DESCRIPTION	U.M.	RANGE	DEFAULT
d4_E00	inS	Enable functions during events day 5.	num	0 ... 8	0
d4_E01_h	inS	Event start time (hours) day 5.	hours	0 ... 23	0
d4_E01_min	inS	Event start time (minutes) day 5.	min	0 ... 59	0
d4_E02	inS	Event duration day 5.	hours	0 ... 72	0
d4_E03	inS	Enable defrost weekdays or weekends day 5.	flag	0 ... 1	0
d5_E00	inS	Enable functions during events day 6.	num	0 ... 8	0
d5_E01_h	inS	Event start time (hours) day 6.	hours	0 ... 23	0
d5_E01_min	inS	Event start time (minutes) day 6.	min	0 ... 59	0
d5_E02	inS	Event duration day 6.	hours	0 ... 72	0
d5_E03	inS	Enable defrost weekdays or weekends day 6.	flag	0 ... 1	0
d6_E00	inS	Enable functions during events day 7.	num	0 ... 8	0
d6_E01_h	inS	Event start time (hours) day 7.	hours	0 ... 23	0
d6_E01_min	inS	Event start time (minutes) day 7.	min	0 ... 59	0
d6_E02	inS	Event duration day 7.	hours	0 ... 72	0
d6_E03	inS	Enable defrost weekdays or weekends day 7.	flag	0 ... 1	0
d7_E00	inS	Enable functions during events day 8.	num	0 ... 8	0
d7_E01_h	inS	Event start time (hours) day 8.	hours	0 ... 23	0
d7_E01_min	inS	Event start time (minutes) day 8.	min	0 ... 59	0
d7_E02	inS	Event duration day 8.	hours	0 ... 72	0
d7_E03	inS	Enable defrost weekdays or weekends day 8.	flag	0 ... 1	0
COMMUNICATION parameters (Add)					
PtS	inS	Protocol selection. t (0) = Televis. d (1) = ModBUS.	flag	t d	t
dEA	inS	Device address: indicates the device address to the management protocol.	num	0 ... 14	0
FAA	inS	Family address: indicates the device family to the management protocol.	num	0 ... 14	0
Adr	inS	ModBUS protocol controller address (only if PtS=d).	num	1 ... 250	1
Pty	inS	Set the ModBUS parity bit (only if PtS = d). n (0) = none. E (1) = parity. o (2) = disparity.	num	n E o	n
StP	inS	ModBUS stop bit: 1b=1 bit; 2b=2 bit.	num	1b/2b	1b
bAU	inS	Baudrate selection. 96 (0) = 9600 192 (1) = 19200 384 (2) = 38400	num	96 192 384	96
DISPLAY parameters (diS)					
LOC	USr/inS	LOCK. Setpoint edit lock. The parameter programming menu can still be accessed, and the settings changed, which means also that the status of this parameter can be changed so as to unlock the keypad. n (0) = no. y (1) = yes.	flag	n/y	n
PA1	USr/inS	PAssword 1. When enabled (PA1 ≠ 0) this password provides access to level1 parameters (User).	num	0 ... 255	0
PA2	inS	PAssword 2. When enabled (PA2 ≠ 0), this password provides access to level2 parameters (Installer).	num	0 ... 255	15
PA3	inS	PAssword 3. When enabled (PA3 ≠ 0), this is the access key used to clear HACCP alarms in the Functions menu.	num	0 ... 255	0
ndt	USr/inS	Display values with decimal point. n (0) = no (integers only). y (1) = yes (display with decimal point).	flag	n/y	y
CA1	USr/inS	Calibration of probe Pb1. Positive or negative temperature value added to the value read by Pb1. This sum is used for both temperature display and temperature regulation purposes.	°C/°F	-30.0...30.0	0.0
CA2	USr/inS	Calibration of probe Pb2. Positive or negative temperature value added to the value read by Pb2. This sum is used for both temperature display and temperature regulation purposes.	°C/°F	-30.0...30.0	0.0
CA3	inS	Calibration of probe Pb3. Positive or negative temperature value added to the value read by Pb3. This sum is used for both temperature display and temperature regulation purposes.	°C/°F	-30.0...30.0	0.0



PAR.	LEV.	DESCRIPTION	U.M.	RANGE	DEFAULT
CA	inS	Offset activation on display, thermoregulation or both: 0 = only the temperature shown is modified. 1 = only the temperature used by the regulators is modified; the display remains unchanged. 2 = temperature displayed is modified, which is also the one used by the regulators.	num	0/1/2	2
LdL	inS	Minimum value that can be displayed by the device.	°C/°F	-58.0...HdL	-50.0
HdL	inS	Maximum value that can be displayed by the device.	°C/°F	LdL...302	140.0
ddl	USr/inS	Display mode during defrost. 0 = displays the temperature read by probe. 1 = locks the reading at the temperature value read by probe when defrosting starts and until the next time the SEt is reached. 2 = displays label def during defrost and until the SEt is reached (or until Ldd elapses).	num	0/1/2	1
Ldd	inS	Timeout value for display unlock - label def .	min	0 ... 255	0
dro	inS	Selection of °C or °F to display the probe value. 0 = °C, 1 = °F. NOTE: switching between °C and °F or vice-versa DOES NOT modify the setpoint, differential, etc. (e.g. setpoint = 10°C becomes 10°F).	flag	0/1	0
ddd	inS	Selects the type of value to show in the display. 0 = Setpoint. 1 = probe Pb1 will be used. 2 = probe Pb2 will be used. 3 = probe Pb3 will be used.	num	0 ... 3	1
dd2	inS	PARAMETER ONLY VISIBLE IN HACCP MODELS Selects the type of value to show in the display. 0 = Setpoint. 1 = RTC.	num	0/1	1
HACCP ALARM parameters (HAC)					
FOLDER ONLY VISIBLE IN HACCP MODELS					
Shi	inS	"Instant" maximum HACCP alarm indication threshold: when the temperature value read by the temperature control probe goes beyond the range set in "SHi", an HACCP alarm is immediately triggered, with light-up of the LED/alarm relay according to parameter H50 (see specific section).	°C/°F	SHH ... 150.0	35.0
SLi	inS	The differential when returning from the alarm condition is fixed at 0.1°C. "Instant" minimum HACCP alarm indication threshold: when the temperature value read by the temperature control probe goes beyond the range set in "SLi", an HACCP alarm is immediately triggered, with light-up of the LED/alarm relay according to parameter H50 (see specific section). The differential when returning from the alarm condition is fixed at 0.1°C.	°C/°F	-50.0 ... SLH	-35.0
SHH	inS	Maximum HACCP alarm indication threshold: when the temperature value displayed by the temperature control probe is outside the range set by the value of "SHH" for longer than the time set in parameter "drA", an HACCP alarm is triggered, with light-up of the LED/(alarm relay) according to parameter H50 (see specific section). The differential when returning from the alarm condition is fixed at 0.1°C.	°C/°F	SLH ... 150.0	30.0
SLH	inS	Minimum HACCP alarm indication threshold: when the temperature value read by the temperature control probe is outside the range set by the value "SLH" for longer than the time set in parameter "drA", an HACCP alarm is triggered, with light-up of the LED/(alarm relay) according to parameter H50 (see specific section). The differential when returning from the alarm condition is fixed at 0.1°C.	°C/°F	-50.0 ... SHH	-30.0
drA	inS	Minimum dwelling time in critical area for the event to be recorded: one this time has elapsed it is saved and an HACCP alarm generated.	min	0 ... 99	10
drH	inS	HACCP alarm reset time from last reset: this is the time that must pass once the instrument has been switched on before any recorded alarms are cleared automatically. If the parameter is set to 0, automatic reset is inhibited and only manual reset is enabled.	hours	0 ... 255	0
H50	inS	Enable HACCP alarms storage with or without alarm relay enabling: IMPORTANT! SWITCH THE INSTRUMENT OFF AND ON AGAIN AFTER MODIFYING PARAMETER H50. • 0 = HACCP alarms disabled. • 1 = HACCP alarms enabled and alarm relay NOT enabled. • 2 = HACCP alarms enabled and alarm relay enabled.	num	0 ... 2	0
H51	inS	HACCP alarms storage disabling time (key or digital input). In minutes.	min	0 ... 255	0
H52	inS	Probe enabled to signal HACCP alarms: 1 = probe 1; 3 = probe 3.	flag	1/3	1



PAR.	LEV.	DESCRIPTION	U.M.	RANGE	DEFAULT		
CONFIGURATION (CnF)							
If one or more parameters present in the folder are changed, the controller MUST be switched off and switched on again.							
H00	Usr/inS	Selection of type of probe used (Pb1 ... Pb3). (0) = PTC. (1) = NTC.	num	0/1	1		
H01	inS	Enable deep cooling function. n (0) = not enabled; y (1) = enabled.	flag	n/y	n		
H02	inS	Activation time for keypad functions	sec	0 ... 15	3		
H06	inS	Key or digital input configured as AUX/LIGHT on with device in stand-by. n = not active; y = active.	flag	n/y	y		
H08	inS	Stand-by operating mode. 0 = the display is off and the regulators on, the device signals any alarms by reactivating the display. 1 = the display is on, plus all regulators including alarms. 2 = the display is off, plus all regulators are locked including alarms. 3 = the upper display shows the label "OFF", plus all regulators are locked including alarms.	num	0/1/2/3	3		
H11	inS	Configuration of digital input 1/polarity. NOTE: - The "+" sign indicates that the input is active when the contact is closed. - The "-" sign indicates that the input is active when the contact is open. <table border="0" style="width: 100%;"> <tr> <td style="vertical-align: top;"> 0 = Disabled ± 1 = Defrost ± 2 = Reduced set ± 3 = Auxiliary AUX ± 4 = Door switch ± 5 = External alarm ± 6 = Disable HACCP alarm storage ± 7 = Stand-by ± 8 = NOT USED ± 9 = Minimum pressure switch </td> <td style="vertical-align: top;"> ±10 = Maximum pressure switch ±11 = General pressure switch ±12 = Preheat ±13 = Force evaporator fans ±14 = Activate light relay ±15 = Activate Frame Heater relay ±16 = Enable/disable Night And Day functions ±17 = Deep cooling cycle ±18 = Panic alarm ±19 = Reset HACCP alarms ±20 = Pressure switch Pump Down </td> </tr> </table>	0 = Disabled ± 1 = Defrost ± 2 = Reduced set ± 3 = Auxiliary AUX ± 4 = Door switch ± 5 = External alarm ± 6 = Disable HACCP alarm storage ± 7 = Stand-by ± 8 = NOT USED ± 9 = Minimum pressure switch	±10 = Maximum pressure switch ±11 = General pressure switch ±12 = Preheat ±13 = Force evaporator fans ±14 = Activate light relay ±15 = Activate Frame Heater relay ±16 = Enable/disable Night And Day functions ±17 = Deep cooling cycle ±18 = Panic alarm ±19 = Reset HACCP alarms ±20 = Pressure switch Pump Down	num	-20 ... +20	4
0 = Disabled ± 1 = Defrost ± 2 = Reduced set ± 3 = Auxiliary AUX ± 4 = Door switch ± 5 = External alarm ± 6 = Disable HACCP alarm storage ± 7 = Stand-by ± 8 = NOT USED ± 9 = Minimum pressure switch	±10 = Maximum pressure switch ±11 = General pressure switch ±12 = Preheat ±13 = Force evaporator fans ±14 = Activate light relay ±15 = Activate Frame Heater relay ±16 = Enable/disable Night And Day functions ±17 = Deep cooling cycle ±18 = Panic alarm ±19 = Reset HACCP alarms ±20 = Pressure switch Pump Down						
H12	inS	Configuration of digital input 2/polarity. Same as H11 .	num	-20 ... +20	0		
H21	inS	Configuration of digital output 1 (OUT 1). <table border="0" style="width: 100%;"> <tr> <td style="vertical-align: top;"> 0 = Disabled 1 = Compressor (cooling) 2 = Defrost 3 = Fans 4 = Alarm 5 = AUX 6 = Stand-by 7 = Light </td> <td style="vertical-align: top;"> 8 = Buzzer output 9 = 2nd evaporator 10 = 2nd compressor 11 = Frame Heater 12 = Condenser fans 13 = Compressor Pump Down </td> </tr> </table>	0 = Disabled 1 = Compressor (cooling) 2 = Defrost 3 = Fans 4 = Alarm 5 = AUX 6 = Stand-by 7 = Light	8 = Buzzer output 9 = 2nd evaporator 10 = 2nd compressor 11 = Frame Heater 12 = Condenser fans 13 = Compressor Pump Down	num	0 ... 13	1
0 = Disabled 1 = Compressor (cooling) 2 = Defrost 3 = Fans 4 = Alarm 5 = AUX 6 = Stand-by 7 = Light	8 = Buzzer output 9 = 2nd evaporator 10 = 2nd compressor 11 = Frame Heater 12 = Condenser fans 13 = Compressor Pump Down						
H22	inS	Configuration of digital output 2 (OUT 2). Same as H21 .	num	0 ... 13	2		
H23	inS	Configuration of digital output 3 (OUT 3). Same as H21 .	num	0 ... 13	3		
H24	inS	PARAMETER ONLY VISIBLE IN MODEL EWRC 500 NT 5 relays Configuration of digital output 4 (OUT 4). Same as H21 .	num	0 ... 13	7		
H25	inS	PARAMETER ONLY VISIBLE IN MODEL EWRC 500 NT 5 relays Configuration of digital output 5 (OUT 5). Same as H21 .	num	0 ... 13	4		
H28	inS	Enable buzzer. (0) = output disabled. (8) = output enabled.	num	0 ... 13	8		
H32	inS	Configuration of DOWN key. <table border="0" style="width: 100%;"> <tr> <td style="vertical-align: top;"> 0 = Disabled 1 = Defrost 2 = Auxiliary 3 = Activate economy setpoint 4 = Reset HACCP alarms 5 = Disable HACCP alarms 6 = Light 7 = Stand-by 8 = NOT USED 9 = Evaporator fans ON </td> <td style="vertical-align: top;"> 10 = Activate / deactivate Frame Heater relay 11 = Enable/disable Night And Day functions 12 = Deep cooling cycle 13 = Clear voltage drop errors (Power Failure Reset) 14 = Service stoppage 15 = Activate economy set + Night And Day </td> </tr> </table>	0 = Disabled 1 = Defrost 2 = Auxiliary 3 = Activate economy setpoint 4 = Reset HACCP alarms 5 = Disable HACCP alarms 6 = Light 7 = Stand-by 8 = NOT USED 9 = Evaporator fans ON	10 = Activate / deactivate Frame Heater relay 11 = Enable/disable Night And Day functions 12 = Deep cooling cycle 13 = Clear voltage drop errors (Power Failure Reset) 14 = Service stoppage 15 = Activate economy set + Night And Day	num	0 ... 15	2
0 = Disabled 1 = Defrost 2 = Auxiliary 3 = Activate economy setpoint 4 = Reset HACCP alarms 5 = Disable HACCP alarms 6 = Light 7 = Stand-by 8 = NOT USED 9 = Evaporator fans ON	10 = Activate / deactivate Frame Heater relay 11 = Enable/disable Night And Day functions 12 = Deep cooling cycle 13 = Clear voltage drop errors (Power Failure Reset) 14 = Service stoppage 15 = Activate economy set + Night And Day						
H33	inS	Configuration of ESC key. Same as H32 .	num	0 ... 15	1		
H34	inS	ON/OFF key configuration. Same as H33 .	num	0 ... 15	7		



PAR.	LEV.	DESCRIPTION	U.M.	RANGE	DEFAULT
H35	inS	LIGHT key configuration. Same as H34.	num	0 ... 15	6
H41	inS	Presence of Cold Room probe Pb1. n= not present; y= present.	flag	n/y	y
H42	USr/inS	Presence of Evaporator probe Pb2. n= not present; y= present.	flag	n/y	y
H43	inS	Presence of probe Pb3. n= not present; y= present.	flag	n/y	n
H44	inS	Setpoint for Pb3-Pb1 temperature differential. Sets the Pb3-Pb1 differential. If H43=3-1, regulation of the temperature differential between probes Pb3 and Pb1, in addition to regulation of probe Pb1, is enabled. In this way, to activate compressor regulation, one or both of the two conditions must be met (on Pb1 or Pb3-Pb1 differential). The differential is defined by H44. To disable the compressor, both conditions must be met, so: • Output enabled if: Pb1>SET+diF, or (Pb3-Pb1) > H44+diF. • Output not enabled if: Pb1<SET and (Pb3-Pb1) < H44.	°C/°F	0...255	0.0
H45	inS	Start defrost mode for applications with double evaporator: 0 = Defrost is enabled by checking only that the temperature of evaporator 1 is lower than the value set in parameter dSt. 1 = Defrost is enabled, checking that the readings from at least one of the two probes is below its defrosting end temperature (dSt for evaporator 1 and dS2 for evaporator 2). 2 = Defrost is enabled, checking that both probe values are below the relative end of defrost Setpoints (dSt for evaporator 1 and dS2 for evaporator 2).	num	0/1/2	0
H48	inS	PARAMETER ONLY VISIBLE IN MODEL EWRC 500 NT HACCP Clock presence. (0) = no clock. (1) = clock present.	flag	n/y	y
rEL	USr/inS	Firmware version release (e.g. 1,2,...). Read only. See Technical Support.	/	/	
tAb	USr/inS	Map code. Read only. See Technical Support.	/	/	
H60	inS	Display of selected application. 0 = no vector selected; 1 = vector 1, ..., 6 = vector 6. It has a subset of parameters which can be programmed in line with the type of configuration required for the installation. By setting H60, the user can also select one of the six 'sets' of pre-programmed parameters. If you do not want to enable any of the available setpoints, but prefer to use the programming menu values, simply set parameter H60 to 0. The parameters corresponding to the different programs are described at the bottom of the table.	num	0 ... 6	0
FRAME HEATER parameters (FrH)					
The Frame Heater function can be selected by key or by Digital Input. This function can be associated to all relay outputs (by setting parameters H21...H25 = 11) and can be used to actuate "Duty Cycle" regulation with the intervals set by parameters HOn and HOF.					
HOn	inS	Frame Heater regulator output ON time.	min	0 ... 255	0
HOF	inS	Frame Heater regulator output OFF time.	min	0 ... 255	0
dt3	inS	Frame Heater regulator time standard unit of measurement: 0 = hours; 1 = minutes; 2 = seconds.	min	0 ... 2	0
COPY CARD parameters (FPr)					
UL		Upload. To transfer programming parameters from instrument to CopyCard.	/	/	
dL		Download. To transfer programming parameters from Copy Card to instrument.	/	/	
Fr		Formatting. To erase data on Copy Card. IMPORTANT: if parameter "Fr" is used, the data entered will be permanently lost. This operation cannot be reversed.	/	/	



7.3.1. PARAMETER H60

Display of selected application.

0 = no vector selected; 1 = vector 1, ..., 6 = vector 6.

It has a subset of parameters which can be programmed in line with the type of configuration required for the installation.

By setting H60, the user can also select one of the six 'sets' of pre-programmed parameters. If you do not want to enable any of the available setpoints, but prefer to use the programming menu values, simply set parameter H60 to 0.

The parameters corresponding to the different programs are described at the bottom of the table.

parameter H60	=1	=2	=3	=4	=5	=6
SEt Temperature control SEtpoint	0.0	2.0	-18.0	2.0	-18.0	5.0
diF Activation differential (absolute or relative)	2.0	2.0	2.0	2.0	2.0	2.0
LSE Maximum value that can be assigned to the setpoint	-50.0	-5.0	-25.0	-5.0	-25.0	2.0
HSE Minimum value that can be assigned to the setpoint	50.0	5.0	-15.0	5.0	-15.0	10.0
dSt Defrost end temperature	6.0	10.0	15.0	10.0	15.0	10.0
FSt Fans disabling temperature	6.0	8.0	-5.0	8.0	-5.0	50.0
dtY Defrost mode	0	1	1	0	0	0
dit Defrost cycle activation delay from request	6	6	6	6	6	6
dCt Defrost timeout	1	1	1	1	1	1
dOH Defrost cycle enabling delay from request	0	0	0	0	0	0
dEt Defrost timeout	30	15	15	30	30	15
Fdt Fans activation delay after a defrost cycle	3	1	2	1	2	0
dt Dripping time. Dripping time	0	2	2	2	2	0
dPO Defrost enabling request from power-on	0	0	0	0	0	0
ddl Display mode during defrost	1	0	0	0	0	0
dFd Operating mode of evaporator fans during defrost	1	1	1	1	1	1

8. ALARMS



8.1. ALARMS AND SIGNALS TABLE

When an alarm condition is detected, the ALARM LED will come on.

If present and enabled, the buzzer and alarm relay will also activate.

To silence the buzzer, press and release any key, the relative icon will continue to flash.

All alarms are reset automatically (i.e. they disappear when the issue that caused them is removed).

The alarm codes are as follows:

Code	Description	Alarm relay	Reset	Parameters involved in ENABLING ALARM
E1	Pb1 probe faulty	active	Automatic	Ont, OFt
E2	Pb2 probe faulty	active	Automatic	Ont, OFt
E3	Pb3 probe faulty	active	Automatic	Ont, OFt
HA1	HIGH temperature alarm	active	Automatic	SP1, Att, AFd, HAL, LAL, PAO, dAO, OAO, tAO
LA1	LOW temperature alarm	active	Automatic	SP1, Att, AFd, HAL, LAL, PAO, dAO, OAO, tAO
EAL	External alarm	active	Automatic	PEA, rLO
OPd	Door open alarm	not active	Automatic	PEA, tdO
Ad2	Defrost end due to timeout	not active	Automatic	dEt, dE2, dAt
PAn	Panic alarm	not active	Automatic	
Prr	Preheat alarm	not active	Automatic	
E10	Clock alarm	not active	Automatic	
PA	General pressure switch alarm	not active	Automatic	PEn, PEi
LPA	Low pressure switch alarm	not active	Automatic	PEn, PEi
HPA	High pressure switch alarm	not active	Automatic	PEn, PEi

NOTES:

- 1) If alarm exclusion times have been set (see "ALr" folder in the parameters table) the alarm will not be signalled.
- 2) With the exception of faulty probe alarms, all other alarms will record the corresponding label in the ALr folder (press UP key).
- 3) Faulty probe alarms will be indicated on the display by means of label E1, E2, E3 depending on whether the fault relates to probe Pb1, Pb2 or Pb3 respectively.



8.2. ALARM CAUSE/EFFECT TABLE

EWRC 300/500 NT can run integral diagnostics on the installation, signalling any operating faults with specific alarms found, and record and signal any user-defined unusual events to have greater control over the system as a whole.

Label	Fault	Cause	Effects	Remedy
E1	Probe Pb1 faulty	<ul style="list-style-type: none"> Measured values are outside operating range Probe faulty/short-circuited/open 	<ul style="list-style-type: none"> Label E1 displayed Alarm icon permanently alight 	<ul style="list-style-type: none"> Check probe type (H00) Check probe wiring Replace probe
E2	Probe Pb2 faulty	<ul style="list-style-type: none"> Measured values are outside operating range. Probe faulty/short-circuited/open 	<ul style="list-style-type: none"> Label E2 displayed Alarm icon permanently alight 	<ul style="list-style-type: none"> Check probe type (H00) Check probe wiring Replace probe
E3	Probe Pb3 faulty	<ul style="list-style-type: none"> Measured values are outside operating range Probe faulty/short-circuited/open 	<ul style="list-style-type: none"> Label E3 displayed Alarm icon permanently alight 	<ul style="list-style-type: none"> Check probe type (H00) Check probe wiring Replace probe
HA1	HIGH temperature alarm 1	Value read by probe 1 > HA1 after time equal to tAO . (see "MAX/MIN TEMP. ALARMS")	<ul style="list-style-type: none"> Label HA1 recorded in folder ALr No effect on regulation 	Wait until value read by the probe returns below HA1-AFd .
LA1	LOW temperature alarm 1	Value read by probe 1 < LA1 after time equal to tAO . (see "MAX/MIN TEMP. ALARMS")	<ul style="list-style-type: none"> Label LA1 recorded in folder ALr No effect on regulation 	Wait until value read by the probe returns above LA1-AFd .
EAL	External alarm	Digital input activated.	<ul style="list-style-type: none"> Label EAL recorded in folder ALr Alarm icon permanently alight Lockout of regulation as requested by rLO 	Check and remove external cause of alarm on D.I.
OPd	Door open alarm	Digital input activated (for a time greater than tdO).	<ul style="list-style-type: none"> Label OPd recorded in folder ALr Alarm icon permanently alight Lockout of regulation as requested by dOd 	<ul style="list-style-type: none"> Close the door Delay preceding defined alarm signal by OAO
Ad2	End of Defrost due to timeout	End of defrost cycle due to timeout rather than due to defrosting end temperature being read by Pb2 .	<ul style="list-style-type: none"> Label Ad2 recorded in folder ALr Alarm icon permanently alight 	Await next defrost cycle for automatic return to normal
Prr	Preheat alarm	Alarm for preheat input regulator ON	<ul style="list-style-type: none"> Label Prr recorded in folder ALr Compressor icon blinking Regulation inhibited (Compressor and Fans) <p>NOTE: defrost will also be blocked if it is hot gas defrost.</p>	Preheat input regulator off.
E10	Clock alarm	<ul style="list-style-type: none"> Clock (RTC) battery spent RTC failure 	<ul style="list-style-type: none"> Label E10 recorded in folder ALr Functions associated with clock not available 	Connect the instrument to the power supply.
P01 ... P99	General pressure switch alarm	Pressure alarm activation by general pressure switch regulator.	<p>If the number n of pressure switch activations is</p> <p style="text-align: center;">$n < PEn$:</p> <ul style="list-style-type: none"> Number of pressure switch activations recorded Regulation inhibited (Compressor and Fans) 	Check and remove external cause of alarm on D.I. (Auto Reset).
PA	General pressure switch alarm	Pressure alarm activation by general pressure switch regulator.	<p>If the number n of pressure switch activations is</p> <p style="text-align: center;">$n = PEn$:</p> <ul style="list-style-type: none"> Label PA displayed Recording of label PA in folder ALr Alarm icon permanently alight Regulation inhibited (Compressor and Fans) 	<ul style="list-style-type: none"> Switch the device off and back on again Reset alarms using the rPA key (Manual Reset)
L01 ... L99	Low pressure switch alarm	Activation of pressure switch alarm by minimum pressure switch regulator.	<p>If the number n of pressure switch activations is</p> <p style="text-align: center;">$n < PEn$:</p> <ul style="list-style-type: none"> Number of pressure switch activations recorded Regulation inhibited (Compressor and Fans) 	Check and remove external cause of alarm on D.I. (Auto Reset).



Label	Fault	Cause	Effects	Remedy
LPA	Low pressure switch alarm	Activation of pressure switch alarm by minimum pressure switch regulator.	If the number n of pressure switch activations is n=PE _n : <ul style="list-style-type: none"> • Label LPA displayed • Recording of label LPA in folder ALr • Alarm icon permanently alight • Regulation inhibited (Compressor and Fans) 	<ul style="list-style-type: none"> • Switch the device off and back on again • Reset alarms using the rPA key (Manual Reset)
H01 ... H99	High pressure switch alarm	Activation of pressure switch alarm by maximum pressure switch regulator.	If the number n of pressure switch activations is n<PE _n : <ul style="list-style-type: none"> • Number of pressure switch activations recorded • Regulation inhibited (Compressor and Fans) 	Check and remove external cause of alarm on D.I. (Auto Reset).
HPA	High pressure switch alarm	Activation of pressure switch alarm by maximum pressure switch regulator.	If the number n of pressure switch activations is n=PE _n : <ul style="list-style-type: none"> • Label PHPA displayed • Label HPA recorded in folder ALr • Alarm icon permanently alight • Regulation inhibited (Compressor and Fans) 	<ul style="list-style-type: none"> • Switch the device off and back on again • Reset alarms using the rPA key (Manual Reset)
PAn	Panic alarm	Digital input activated.	<ul style="list-style-type: none"> • Recording of label PAn in the alarms menu • Permanent illumination of Panic alarm LED • Regulation inhibited 	Check and remove external cause of alarm on D.I. (Auto Reset).

ALL ALARMS

- Alarm icon permanently alight

Buzzer (if present) and alarm relay (OUT5) activated, except Ad2

Press any key to silence the alarm. The LED changes from a steady light to a blinking light. NOTE: the buzzer is deactivated while the alarm relay remains active

*E1 - E2: If simultaneous they will be shown alternately on the display at a frequency of 2 seconds



8.3. DESCRIPTION OF ALARMS

8.3.1. PROBE ALARM

OPERATING CONDITIONS

When one of the probes is out of the nominal operating range or in the case of an open probe or a probe in short circuit, an alarm is generated if this condition persists for longer than 10 seconds.

The alarm condition is indicated on the display by means of the following error codes:

- **E1** = Probe Pb1 faulty
- **E2** = Probe Pb2 faulty
- **E3** = Probe Pb3 faulty

The alarm LED and alarm relay are activated. Codes **E1**, **E2**, **E3**, when occurring at the same time, are shown in the following sequence: E1 x 2 sec, E2 x 2 sec, E3 x 2 sec, etc.

ACTIONS ON CURRENT REGULATION

For all probes, the probe error condition causes the following actions:

- the display shows code **E_x** (where **x** = 1, 2, 3)
- activation and permanent display of alarm icon and activation of alarm relay (if present)

When the faulty probe condition ceases, regulation resumes as normal.

During the probe error, the defrost interval count continues as normal.

SIGNALLING

Code	Meaning
E1	Probe Pb1 error
E2	Probe Pb2 error
E3	Probe Pb3 error

ALARM ACKNOWLEDGMENT

In the alarm condition, it is possible to acknowledge the alarm and/or relay configured as an alarm, even if the alarm condition persists, by pressing any key or using the corresponding function in the menu. The alarm LED will start to blink.

Eliminating the cause of the alarm disarms the acknowledgement.

The probe fault alarm is not stored by the controller.

USER PARAMETERS

Label	Description
Ont	ON time for compressor output with faulty control probe
OFt	OFF time for compressor output with faulty control probe



8.3.2. MINIMUM AND MAXIMUM TEMPERATURE ALARM

OPERATING CONDITIONS

The alarm regulation is carried out on probe 1. The temperature limits defined in parameters **HAL** and **LAL** are determined by parameter **Att** which specifies if they represent the absolute temperature value or a setpoint differential (in the case of offset on the entered setpoint, the high and low alarms will refer to this new control setpoint).

- If **Att** = 0 **Ab(solute)**, the temperature limits for probe 1/2 are absolute.
- If **Att** = 1 **rE(lative)**, the temperature limits for probe 1/2 refer to the **SEt**.

 **NOTE:** to obtain the minimum alarm below the setpoint in the case of **Att=1** (relative) it is necessary to set **LAL** < 0.

ALARM CONDITIONS

A maximum/minimum alarm is generated when the Pb1 temperature is:

- Maximum alarm: $\geq \text{HAL}$ if **Att=Ab(solute)** and $\geq (\text{SEt} + \text{HAL})$ if **Att=rE(lative)**
- Minimum alarm: $\leq \text{LAL}$ if **Att=Ab(solute)** and $\leq (\text{SEt} + \text{LAL})$ if **Att=rE(lative)**

If **Att=Ab(solute)** the values of **HAL** and **LAL** must be with sign, if **Att=rE(lative)** it is necessary that **HAL** > 0 and **LAL** < 0.

When one of the two aforementioned conditions occurs, if no alarm override times apply (see alarm override parameters), the alarm LED lights up and the relay configured as alarm activates (if present).

The maximum/minimum alarm will be reset when the temperature of probe 1/2 is:

- Reset from maximum alarm: $\leq (\text{HAL} - \text{AFd})$ if **Att=Ab(solute)** and $\leq (\text{SEt} + \text{HAL} - \text{AFd})$ if **Att=rE(lative)**
- Reset from minimum alarm: $\geq (\text{LAL} + \text{AFd})$ if **Att=Ab(solute)** and $\geq (\text{SEt} + \text{LAL} + \text{AFd})$ if **Att=rE(lative)**

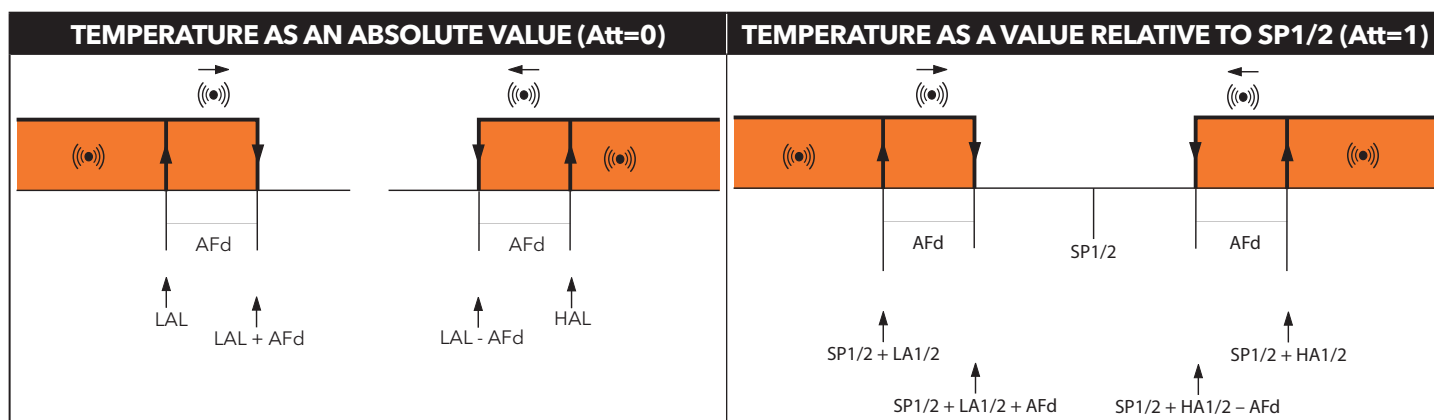

 **NOTES:**

- During a defrost cycle, high and low temperature alarms are overridden.
- Occurrence of this alarm does not effect any regulation in progress.

SIGNALLING

Code	Meaning
HA1	HIGH temperature alarm, refers to probe
LA1	LOW temperature alarm, refers to probe

ALARM ACKNOWLEDGMENT

In the alarm condition, it is possible to acknowledge the relay configured as an alarm (if present), even if the alarm condition persists, by pressing any key or using the corresponding function in the menu. The alarm LED will start to blink.

Eliminating the cause of the alarm disarms the acknowledgement.

The probe fault alarm is not stored by the controller.

USER PARAMETERS

Label	Description
Att	HAL and LAL parameter mode (absolute or relative)
AFd	Alarm activation differential
HAL	Probe maximum alarm threshold
LAL	Probe minimum alarm threshold
PAO	Temperature alarm exclusion time from power-on
dAO	Temperature alarm disabling time after defrost cycle
OAO	High/low temperature alarm exclusion time after door closing
tAO	Temperature alarms delay time



8.3.3. END OF DEFROST DUE TO TIMEOUT ALARM

OPERATING CONDITIONS

The regulator is activated without any delay in the case of end of defrost due to timeout, instead of probe 2 reaching the defrost end temperature.

The action consists of:

- Permanent illumination of alarm LED
- Recording of label **Ad2** in the alarms menu

Automatic reset occurs with the start of the next defrost cycle.

The alarm LED can be switched off using the normal acknowledgement procedure, although the alarm signal is only actually cancelled at the start of the next defrost cycle.

SIGNALLING

Code	Meaning
Ad2	Defrost alarm on Pb2

USER PARAMETERS

Label	Description
dEt	Evaporator 1 defrost timeout
dE2	Evaporator 2 defrost timeout
dAt	Alarm signalling end of defrost due to timeout

8.3.4. EXTERNAL ALARM

OPERATING CONDITIONS

In the case of activation of the digital input, the alarm regulator is activated with the delay set by parameter **dAd**, and this alarm persists until the next time the digital input is deactivated.

The action consists of:

- Permanent illumination of alarm LED
- Recording of label **EAL** in the alarms menu
- Activation of the relay configured as alarm (if enabled)
- Deactivation of regulation if parameter **rLO** requires it.

It is possible to lock the alarm relay but the regulators still remain locked until the next time the digital input is deactivated.

The values that can be assigned to parameter **rLO** are:

- **rLO = 0**: an external alarm has not locked any resource;
- **rLO = 1**: an external alarm has locked the compressor and defrost;
- **rLO = 2**: an external alarm has locked the compressor, defrost and the fans.

SIGNALLING

Code	Meaning
EAL	External alarm

USER PARAMETERS

Label	Description
rLO	An external alarm blocks the regulators



8.3.5. DOOR OPEN ALARM

OPERATING CONDITIONS

The door switch alarm is associated to a specially configured digital input:

- **H11, H12, = ± 4**

On activation of the digital input (door open) and after delay **tdO** has elapsed, the door open alarm must be signalled in the alarms folder and the LED and alarm relay must light up. The label **OPd** is displayed.

The action consists of:

- Permanent illumination of alarm LED
- Recording of label **OPd** in the alarms menu
- Activation of the relay configured as alarm

As in the case of the other alarms, the relay may be deactivated by pressing an acknowledgement key, the alarm LED will blink and label **OPd** will remain in the alarms menu until the door is closed.

If the door is opened, the regulator will operate on the basis of the value of parameter **dOd**. The values that can be assigned to it are:

- **dOd = 0**: no resource is locked;
- **dOd = 1**: fans are locked (FAN);
- **dOd = 2**: the compressor is locked (COMPR);
- **dOd = 3**: both the fans (FAN) and compressor (COMPR) are locked.

If the door open alarm locks the compressor, it can still be reactivated even if the door remains open, by setting the parameter **dCO**.

SIGNALLING

Code	Meaning
OPd	Door open alarm

USER PARAMETERS

Label	Description
dOd	Digital input for switching off loads: 0 = disabled; 1 = fans disabled; 2 = compressor disabled; 3 = fans and compressor disabled.
dCO	Compressor activation delay from acknowledgement
tdO	Open door disabling time



8.3.6. PRESSURE SWITCH INPUT ALARM

OPERATING CONDITIONS

The pressure switch is associated with a suitably configured Digital Input and can be general, minimum or maximum.



NOTE: behaviour and configuration parameters are the same for all three types.

Every time pressure switch input activation causes the compressor/fans to be deactivated instantly, with only visual indication of the activation (WARNING) provided via illumination of the alarm LED and recording of the number of pressure switch activations that have taken place.

If the pressure switch Digital Input is deactivated, the compressor starts up again and the alarm LED switches off, but the alarm folder still contains the number of activations recorded in the previous counting interval (defined using parameter PEi).

Once the number of activations set in parameter **PEn** has been reached, **PA** (general), **LPA** (minimum) or **HPA** (maximum) will appear on the display.

Compressor, fans and defrosts are deactivated, the alarm LED lights up and the alarm relay comes on if configured. Once the device has entered alarm mode, it must be switched off and on again, or a key-activated reset performed using the function **rPA** (reset pressure switch alarm) on the functions menu.



NOTE: the value **PEn** represents the number of pressure switch activations within the interval defined in parameter PEI, which determines activation of alarm mode and deactivation of the compressor, fan and defrost outputs.
If **PEn = 0** the function is excluded and the pressure switch alarm is ignored.

SIGNALLING

Code	Meaning
PA	General pressure switch alarm
LPA	Minimum pressure switch alarm
HPA	Maximum pressure switch alarm

USER PARAMETERS

Label	Description
PEn	Number of errors allowed per pressure switch input. 0 = disabled.
PEi	Pressure switch error count interval.

8.3.7. PANIC ALARM

OPERATING CONDITIONS

The panic alarm is associated to a specially configured digital input:

- **H11, H12, = ± 18**

After the delay set in parameter dAd, this alarm is activated and persists until the next digital input deactivation.

The action consists of:

- Permanent illumination of Panic alarm LED
- Recording of label **PAn** in the alarms menu
- Activation of the relay configured as alarm (if enabled)

It is possible to lock the alarm relay but the regulators still remain locked until the next time the digital input is deactivated.

SIGNALLING

Code	Meaning
PAn	Panic alarm

USER PARAMETERS

Label	Description
dAd	Activation delay DI1 and DI 2

9. MODBUS MSK 554 FUNCTIONS AND RESOURCES



ModBUS is a client/server protocol for communication between devices connected in a network.

ModBUS devices communicate using a master-slave technique in which only one device (master) can send messages.

The other devices in the network (slave) respond, returning the data requested by the master or executing the action contained in the message sent.

A slave is a device connected to a network that processes information and sends the results to the master using the ModBUS protocol. The master device can send messages to individual slaves or to the entire network (broadcast) whilst slaves can only respond individually to the master.

The ModBUS standard used by Eliwell employs the RTU code for data transmission.

9.3.1. DATA FORMAT (RTU)

The coding model used defines the structure of messages transmitted on the network and the way in which this information is deciphered. The type of coding is usually selected on the basis of specific parameters (baud rate, parity, etc.); furthermore, some devices support only specific coding models, although it must be the same one for all devices connected in a ModBUS network.

The protocol uses the RTU binary method with bytes configured as follows: **8 bit for data, none parity bit (configurable), 2 stop BIT.**

NOTE: the transmission speed must be set at 9600 baud.

Parameter setting allows the integral configuration of the device

They can be modified through:

- Device keypad
- Copy Card
- Sending data via ModBUS protocol directly to an individual controller or broadcasting it using the address 0.

9.3.2. NETWORK

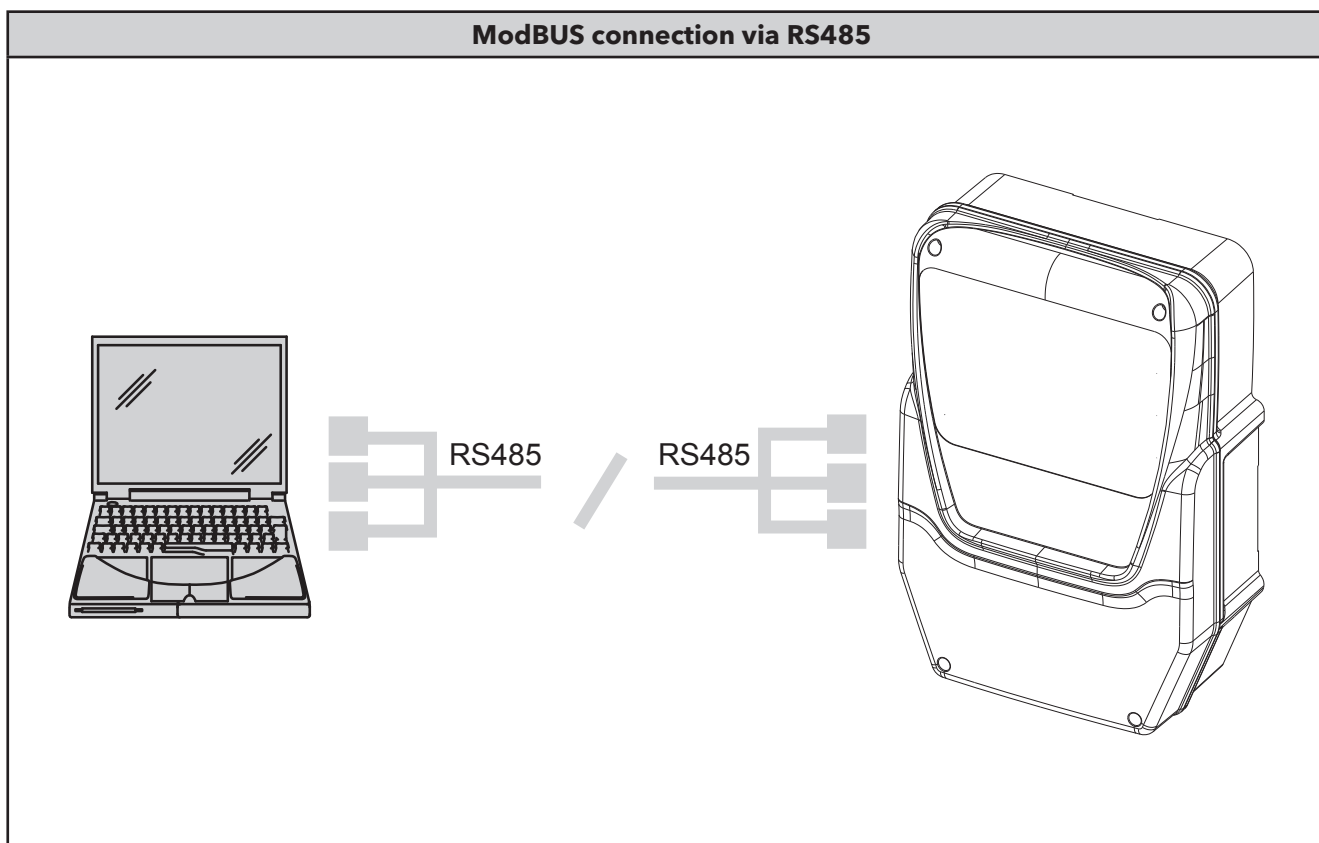



9.3.3. MODBUS COMMANDS AVAILABLE AND DATA AREAS

The following commands are implemented:

ModBUS command	Description of command								
03 (hex 0x03)	Read 16 consecutive registers for Client side.								
04 (hex 0x04)	Read 1 single register for parameters.								
16 (hex 0x10)	Write 15 consecutive registers for Client side.								
22 (hex 0x16)	Write 1 register for the parameters.								
43 (hex 0x2B)	Read device ID. It is possible to read the following 3 fields: <table border="1" data-bbox="632 689 1439 891" style="margin-left: 40px;"> <thead> <tr> <th>Field code</th> <th>Field description</th> </tr> </thead> <tbody> <tr> <td>0</td> <td>Manufacturer ID (= "Invensys")</td> </tr> <tr> <td>1</td> <td>Device model/polycarbonate ID</td> </tr> <tr> <td>2</td> <td>Family ID (MSK 554)/ instrument version</td> </tr> </tbody> </table>	Field code	Field description	0	Manufacturer ID (= "Invensys")	1	Device model/polycarbonate ID	2	Family ID (MSK 554)/ instrument version
Field code	Field description								
0	Manufacturer ID (= "Invensys")								
1	Device model/polycarbonate ID								
2	Family ID (MSK 554)/ instrument version								

Length restrictions

Maximum length in bytes of messages sent to device	30 BYTES
Maximum length in bytes of messages received by the device	30 BYTES

9.3.4. ADDRESS CONFIGURATION

The serial TTL - which we will call COM1 - can be used to configure the device, parameters, statuses, and variables with ModBUS via the ModBUS protocol.

The address of a device within a ModBUS message is set using the parameter **Adr**.

The address 0 is used for broadcast messages that all slaves recognise. Slaves don't respond to broadcast messages. The parameters for configuring the device are:

Parameter	Description	Values	Range
PtS	Select COM1 (TTL) protocol	d	t = Televis d = ModBUS
Adr	ModBUS protocol controller address	1	1 ... 250
Pty	ModBUS protocol parity bit	n	<ul style="list-style-type: none"> • n= NONE • E = EVEN (parity) • o = ODD (disparity)
bAU	Baudrate selection	96	<ul style="list-style-type: none"> • 96 = 9600 baud • 192 = 19200 baud • 384 = 38400 baud

NOTE: to guarantee correct operation, the controller must be switched off and switched on again after modification

IMPORTANT: remember to set **1 BIT** of stop.



9.3.5. PARAMETER VISIBILITY AND VALUES

IMPORTANT:

- 1) When not indicated otherwise, the parameter is always visible and modifiable, unless customised settings have been configured by the user via serial.
- 2) If folder visibility is modified, the new setting will apply to all parameters in the folder.

9.3.6. MODBUS TABLES

The tables below list all information required to read, write and decode all accessible resources in the device. There are 3 tables:

- the "**PARAMETER TABLE**" contains all device configuration parameters stored in the controller's non-volatile memory, including visibility
- the "**FOLDER VISIBILITY TABLE**" indicates the visibility of the folders containing the parameters
- the "**CLIENT TABLE**" includes all I/O and alarm status resources available in the volatile memory of the instrument.

Description of columns:

FOLDER

Indicates the label of the folder containing the parameter in question.

LABEL

Indicates the label used to display the parameters in the menu of the controller.

PAR. VALUE ADDRESS

The whole part represents the address of the ModBUS register containing the value of the resource to be read or written in the controller. The value after the decimal point indicates the position of the most significant data bit inside the register; if not indicated it is taken to be zero. This information is always provided when the register contains more than one information item, and it is necessary to distinguish which bits actually represent the data (the working size of the data indicated in the column DATA SIZE is also taken into consideration).

Given that the ModBUS registers have the size of one WORD (16 bit), the index number after the point can vary from 0 (least significant bit -LSb-) to 15 (most significant bit -MSb-).

Examples (in binary form the least significant bit is the first on the right):

PAR. VALUE ADDRESS	DATA SIZE	Value		Content of register
8806	WORD	1350	1350	(0000010101000110)
8806	BYTE	70	1350	(00000101 01000110)
8806.8	BYTE	5	1350	(00000101 01000110)
8806.14	1 BIT	0	1350	(0 0000 010101000110)
8806.7	4 BIT	10	1350	(00000 1010 1000110)

IMPORTANT: when the register contains more than one piece of data, the write procedure is as follows:

- Read current value of register
- Modify bits for the resource concerned
- Write register

VIS PAR. ADDRESS

The same as above. In this case, the ModBUS register address contains the visibility value of the parameter.

By default all parameters have:

- Data size 2 bit
- Range 0...3
- **Visibility 3
- U.M. num

**Value Meaning

- Value 3 = parameter or folder always visible
- Value 2 = **installer level**; these parameters can only be viewed by entering the manufacturer password (see parameter PS2) (all parameters specified as always visible, parameters visible at the installer level and manufacturer level will be visible)
- Value 1 = **user level**; these parameters can only be viewed by entering the installer password (see parameter PS1) (all parameters specified as always visible and parameters visible at the installer level will be visible)
- Value 0 = parameter or folder NOT visible

1. Parameters and/or folders with a level of visibility <>3 (password-protected) will be visible only if the correct password is entered (installer or user) following this procedure:
2. Parameters and/or folders with a level of visibility =3 are always visible even without a password: in this case, the following procedure is not necessary.



Examples (in binary form the least significant bit is the first on the right):

Default visibility:

PAR. VALUE ADDRESS	DATA SIZE	Value		Content of register
49336.6	2 BIT	3	65535	------(00000000 11 1111111111111111)
49337	2 BIT	3	65535	(00000000111111 11 1111111111)
49337.2	2 BIT	3	65535	(000000001111 11 111111111111)
49337.4	2 BIT	3	65535	(0000000011 11 11111111111111)
49337.6	2 BIT	3	65535	(00000000 11 1111111111111111)

R/W

Indicates the option of reading or writing the resource

- R The resource is read-only
- W The resource is write-only
- RW The resource can be both read and written

DESCRIPTION

This is the description of the meaning of **parameters** in the **LABEL** column.

DATA SIZE

Indicates the size of the data in bits.

- WORD = 16 bit
- Byte = 8 bit
- "n" bit = 0...15 bit based on the value of "n"

CPL

When the field indicates "Y", the value read by the register needs to be converted because the value represents a number with a sign. In the other cases the value is always positive or null.

To carry out conversion, proceed as follows:

- If the value in the register is between 0 and 32.767, the result is the value itself (zero and positive values)
- If the value in the register is between 32.768 and 65.535, the result is the value of the register - 65.536 (negative values)

RANGE

Describes the interval of values that can be assigned to the parameter. It can be correlated with other parameters in the instrument (indicated with the parameter label).

U.M.

Unit of measurement for values converted according to the rules indicated in the CPL and EXP columns.



9.3.7. PARAMETER/VISIBILITY TABLE

NOTE: ModBUS read command: 04 (0x04) and ModBUS write command: 22 (0x16)

FOLDER	LABEL	PAR. Value ADDRESS	Vis. PAR. ADDRESS	R/W	DESCRIPTION	DATA SIZE	CPL	EXP	U.M.	RANGE
/	SEt	16386	49455	RW	Setpoint	WORD	Y		°C/°F	LSE...HSE
CPr	diF	16388	49455.2	RW	Setpoint differential	WORD	Y	-1	°C/°F	0 ... 30.0
CPr	HSE	16390	49455.4	RW	Maximum setpoint value that can be set	WORD	Y	-1	°C/°F	LSE ... HdL
CPr	LSE	16392	49455.6	RW	Minimum setpoint value that can be set	WORD	Y	-1	°C/°F	LdL ... HSE
CPr	OSP	16394	49456	RW	Offset on setpoint	WORD	Y	-1	°C/°F	-30.0 ... 30.0
CPr	Cit	49235	49456.4	RW	Minimum compressor output activation time	BYTE			min	0 ... 255
CPr	CAt	49236	49456.6	RW	Maximum compressor output activation time	BYTE			min	0 ... 255
CPr	Ont	49237	49457	RW	ON time for compressor output with faulty control probe	BYTE			min	0 ... 255
CPr	Oft	49238	49457.2	RW	OFF time for compressor output with faulty control probe	BYTE			min	0 ... 255
CPr	dOn	49239	49457.4	RW	Compressor output activation delay from request	BYTE			sec	0 ... 255
CPr	dOF	49240	49457.6	RW	Compressor output activation delay from shutdown	BYTE			min	0 ... 255
CPr	dbi	49241	49458	RW	Delay between two consecutive starts of the compressor output	BYTE			min	0 ... 255
CPr	OdO	49242	49458.2	RW	Output activation delay from power-on	BYTE			min	0 ... 255
CPr	dSC	49243	49458.4	RW	Compressor activation delay	BYTE			sec	0 ... 255
CPr	dCS	16396	49458.6	RW	Deep Cooling setpoint	WORD	Y	-1	°C/°F	-58.0 ... 302.0
CPr	tdc	16398	49459	RW	Deep Cooling Duration	WORD			min	0 ... 600
CPr	dcc	49244	49459.2	RW	Defrost delay after deep cooling cycle.	BYTE			min	0 ... 255
dEF	dtY	49245	49459.4	RW	Defrost mode	BYTE			num	0...2
dEF	dit	49246	49459.6	RW	Interval between defrost cycles	BYTE			hours/ mins/secs	0...255
dEF	dt1	49247	49460	RW	Unit of measurement for defrost interval	BYTE			num	0/1/2
dEF	dt2	49248	49460.2	RW	Unit of measurement for defrost duration	BYTE			num	0/1/2
dEF	dCt	49249	49460.4	RW	Defrost interval count mode	BYTE			num	0...3
dEF	dOH	49250	49460.6	RW	Defrost interval count mode	BYTE			min	0...59
dEF	dEt	49251	49461	RW	Evaporator 1 defrost timeout	BYTE			hours/ mins/secs	1...255
dEF	dSt	16400	49461.2	RW	Probe 1 defrost end temperature	WORD	Y	-1	°C/°F	-58.0...302.0
dEF	dS2	16402	49461.4	RW	Probe 2 defrost end temperature	WORD	Y	-1	°C/°F	-58.0...302.0
dEF	dE2	49252	49461.6	RW	Evaporator 2 defrost timeout	BYTE			hours/ mins/secs	1...250
dEF	dPO	49253	49462	RW	Defrost activation request from power-on	BYTE			flag	0/1
dEF	tcd	16404	49462.2	RW	Minimum compressor ON or OFF time before defrost	WORD	Y		min	-31...31
dEF	Code	49254	49462.4	RW	Time preceding a defrost, during which the compressor output is not activated	BYTE			min	0...60
dEF	dE1_h	49341		RW	Defrost start time (minutes) no. 1 weekday	BYTE			hours	0 ... 24
dEF	dE1_min	49340		RW	Defrost start time (hours) no. 2 weekday	BYTE			min	0 ... 59
dEF	dE2_h	49343		RW	Defrost start time (minutes) no. 2 weekday	BYTE			hours	0 ... 24
dEF	dE2_min	49342		RW	Defrost start time (hours) no. 3 weekday	BYTE			min	0 ... 59
dEF	dE3_h	49345		RW	Defrost start time (minutes) no. 3 weekday	BYTE			hours	0 ... 24
dEF	dE3_min	49344		RW	Defrost start time (hours) no. 4 weekday	BYTE			min	0 ... 59
dEF	dE4_h	49347		RW	Defrost start time (minutes) no. 4 weekday	BYTE			hours	0 ... 24
dEF	dE4_min	49346		RW	Defrost start time (hours) no. 5 weekday	BYTE			min	0 ... 59
dEF	dE5_h	49349		RW	Defrost start time (minutes) no. 5 weekday	BYTE			hours	0 ... 24
dEF	dE5_min	49348		RW	Defrost start time (hours) no. 6 weekday	BYTE			min	0 ... 59
dEF	dE6_h	49351		RW	Defrost start time (minutes) no. 6 weekday	BYTE			hours	0 ... 24
dEF	dE6_min	49350		RW	Defrost start time (hours) no. 7 weekday	BYTE			min	0 ... 59
dEF	dE7_h	49353		RW	Defrost start time (minutes) no. 7 weekday	BYTE			hours	0 ... 24
dEF	dE7_min	49352		RW	Defrost start time (hours) no. 8 weekday	BYTE			min	0 ... 59
dEF	dE8_h	49355		RW	Defrost start time (minutes) no. 8 weekday	BYTE			hours	0 ... 24
dEF	dE8_min	49354		RW	Weekday defrost 3 duration	BYTE			min	0 ... 59
dEF	F1_h	49357		RW	Defrost start time (hours) no. 1 weekend	BYTE			hours	0 ... 24



FOLDER	LABEL	PAR. Value ADDRESS	Vis. PAR. ADDRESS	R/W	DESCRIPTION	DATA SIZE	CPL	EXP	U.M.	RANGE
dEF	F1_min	49356		RW	Defrost start time (minutes) no. 1 weekend	BYTE			min	0 ... 59
dEF	F2_h	49359		RW	Defrost start time (hours) no. 2 weekend	BYTE			hours	0 ... 24
dEF	F2_min	49358		RW	Defrost start time (minutes) no. 2 weekend	BYTE			min	0 ... 59
dEF	F3_h	49361		RW	Defrost start time (hours) no. 3 weekend	BYTE			hours	0 ... 24
dEF	F3_min	49360		RW	Defrost start time (minutes) no. 3 weekend	BYTE			min	0 ... 59
dEF	F4_h	49363		RW	Defrost start time (hours) no. 4 weekend	BYTE			hours	0 ... 24
dEF	F4_min	49362		RW	Defrost start time (minutes) no. 4 weekend	BYTE			min	0 ... 59
dEF	F5_h	49365		RW	Defrost start time (hours) no. 5 weekend	BYTE			hours	0 ... 24
dEF	F5_min	49364		RW	Defrost start time (minutes) no. 5 weekend	BYTE			min	0 ... 59
dEF	F6_h	49367		RW	Defrost start time (hours) no. 6 weekend	BYTE			hours	0 ... 24
dEF	F6_min	49366		RW	Defrost start time (minutes) no. 6 weekend	BYTE			min	0 ... 59
dEF	F7_h	49369		RW	Defrost start time (hours) no. 7 weekend	BYTE			hours	0 ... 24
dEF	F7_min	49368		RW	Defrost start time (minutes) no. 7 weekend	BYTE			min	0 ... 59
dEF	F8_h	49371		RW	Defrost start time (hours) no. 8 weekend	BYTE			hours	0 ... 24
dEF	F8_min	49370		RW	Defrost start time (minutes) no. 8 weekend	BYTE			min	0 ... 59
FAn	FPt	49255	49463	RW	FSt parameter mode	BYTE			flag	0/1
FAn	FSt	16406	49463.2	RW	Fans disabling temperature	WORD	Y	-1	°C/°F	-58.0...302.0
FAn	Fot	16408	49463.4	RW	Evaporator fans start temperature	WORD	Y	-1	°C/°F	-58.0...302.0
FAn	FAd	16410	49463.6	RW	Fans differential	WORD		-1	°C/°F	0.1...25.0
FAn	Fdt	49256	49464	RW	Fan activation delay from compressor start	BYTE			min	0...255
FAn	dt	49257	49464.2	RW	Dripping time	BYTE			min	0...255
FAn	dFd	49258	49464.4	RW	Evaporator fans mode in defrost	BYTE			flag	0/1
FAn	FCO	49259	49464.6	RW	Evaporator fans mode	BYTE			num	0...4
FAn	FdC	49261	49465.2	RW	Fan switch-off delay from compressor stoppage	BYTE			min	0...255
FAn	FOn	49262	49465.4	RW	Fans ON time in duty cycle	BYTE			min	0...255
FAn	FOF	49263	49465.6	RW	Fans OFF time in duty cycle	BYTE			min	0...255
FAn	SCF	16412	49466	RW	Condenser fans activation Setpoint	WORD		-1	°C/°F	-50.0...150.0
FAn	dCF	16414	49466.2	RW	Condenser fans activation differential	WORD		-1	°C/°F	-30.0...30.0
FAn	tCF	49264	49466.4	RW	Condenser fans switch-on delay after defrost	BYTE			min	0...59
FAn	dCd	49265	49466.6	RW	Condenser fans exclusion during defrost	BYTE			flag	0/1
AL	Att	49266	49467	RW	HAL and LAL parameter mode	BYTE			flag	0/1
AL	AFd	16416	49467.2	RW	Alarm setpoint differential	WORD		-1	°C/°F	0.1...50.0
AL	HAL	16418	49467.4	RW	Maximum alarm	WORD	Y	-1	°C/°F	LA1...302.0
AL	LAL	16420	49467.6	RW	Minimum alarm	WORD	Y	-1	°C/°F	-58.0...HA1
AL	PAO	49267	49468	RW	Alarm exclusion at power-on	BYTE			hours	0...10
AL	dAO	16422	49468.2	RW	Alarm exclusion after defrost	WORD			min	0...255
AL	OAO	49268	49468.4	RW	Alarm signalling delay from door closure	BYTE			hours	0...10
AL	tdO	49269	49468.6	RW	Open door disabling time	BYTE			min	0...255
AL	tAO	49270	49469	RW	Temperature alarms signalling delay	BYTE			min	0...255
AL	dAt	49271	49469.2	RW	Enable alarm at end of defrost	BYTE			flag	0/1
AL	rLO	49272	49469.4	RW	External alarm switches off loads	BYTE			num	0/1/2
AL	AOP	49273	49469.6	RW	Alarm output polarity	BYTE			flag	0 / 1
AL	PbA	49275	49470.2	RW	Probe enabled to signal temperature alarms (probe 1 and/or 3)	BYTE			num	0 ... 3
AL	SA3	16424	49470.4	RW	Alarm setpoint related to probe 3	WORD	Y	-1	°C/°F	-50.0 ... 150.0
AL	dA3	16426	49470.6	RW	Probe 3 alarm activation differential	WORD	Y	-1	°C/°F	-30.0 ... 30.0
AL	tA3	49276	49471	RW	Alarm 3 signalling delay time	BYTE			min	0 ... 59
AL	ArE	49277	49471.2	RW	Enables alarm relay in the event of probe 3-related alarms	BYTE			num	0/1/2
Lit	dSd	49278	49471.4	RW	Enable light relay from door switch	BYTE			flag	0/1
Lit	dLt	49279	49471.6	RW	Light relay deactivation delay	BYTE			min	0...31
Lit	OFL	49280	49472	RW	Light key always disables light relay	BYTE			flag	0/1
Lit	dOd	49281	49472.2	RW	Door switch switches off loads	BYTE			num	0...3
Lit	dAd	49282	49472.4	RW	Activation delay for digital inputs	BYTE			min	0...255
Lit	dOA	49285	49473.2	RW	Action forced by digital input	BYTE			num	0...5
Lit	PEA	49286	49473.4	RW	Select DI for lock/unlock resources function	BYTE			num	0...3



FOLDER	LABEL	PAR. Value ADDRESS	Vis. PAR. ADDRESS	R/W	DESCRIPTION	DATA SIZE	CPL	EXP	U.M.	RANGE
Lit	dCO	49287	49473.6	RW	Evaporator fan compressor activation/switch-off delay	BYTE			min	0...255
Lit	dOC	49260	49465		Compressor activation/switch-off delay after request	BYTE			min	0...255
Lit	dFO	49288	49474	RW	Evaporator fan activation/switch-off delay	BYTE			min	0...255
Lit	PEn	49334	49474.2	RW	Number of errors permitted	BYTE			num	0...15
Lit	PEi	49335	49474.4	RW	Error count interval	BYTE			min	1...99
nAd	d1_E00	49372	--	RW	Enable functions during events day 1	BYTE			num	0 ... 8
nAd	d1_E01_h	49397	--	RW	Event start time (hours) day 1	BYTE			hours	0 ... 23
nAd	d1_E01_m	49396	--	RW	Event start time (minutes) day 1	BYTE			min	0 ... 59
nAd	d1_E02	49380	--	RW	Event duration day 1	BYTE			hours	0 ... 72
nAd	d1_E03	49388	--	RW	Enable defrost weekdays or weekends day 1	BYTE			flag	0 ... 1
nAd	d2_E00	49373	--	RW	Enable functions during events day 2	BYTE			num	0 ... 8
nAd	d2_E01_h	49399	--	RW	Event start time (hours) day 2	BYTE			hours	0 ... 23
nAd	d2_E01_m	49398	--	RW	Event start time (minutes) day 2	BYTE			min	0 ... 59
nAd	d2_E02	49381	--	RW	Event duration day 2	BYTE			hours	0 ... 72
nAd	d2_E03	49389	--	RW	Enable defrost weekdays or weekends day 2	BYTE			flag	0 ... 1
nAd	d3_E00	49374	--	RW	Enable functions during events day 3	BYTE			num	0 ... 8
nAd	d3_E01_h	49401	--	RW	Event start time (hours) day 3	BYTE			hours	0 ... 23
nAd	d3_E01_m	49400	--	RW	Event start time (minutes) day 3	BYTE			min	0 ... 59
nAd	d3_E02	49382	--	RW	Event duration day 3	BYTE			hours	0 ... 72
nAd	d3_E03	49390	--	RW	Enable defrost weekdays or weekends day 3	BYTE			flag	0 ... 1
nAd	d4_E00	49375	--	RW	Enable functions during events day 4	BYTE			num	0 ... 8
nAd	d4_E01_h	49403	--	RW	Event start time (hours) day 4	BYTE			hours	0 ... 23
nAd	d4_E01_m	49402	--	RW	Event start time (minutes) day 4	BYTE			min	0 ... 59
nAd	d4_E02	49383	--	RW	Event duration day 4	BYTE			hours	0 ... 72
nAd	d4_E03	49391	--	RW	Enable defrost weekdays or weekends day 4	BYTE			flag	0 ... 1
nAd	d5_E00	49376	--	RW	Enable functions during events day 5	BYTE			num	0 ... 8
nAd	d5_E01_h	49405	--	RW	Event start time (hours) day 5	BYTE			hours	0 ... 23
nAd	d5_E01_m	49404	--	RW	Event start time (minutes) day 5	BYTE			min	0 ... 59
nAd	d5_E02	49384	--	RW	Event duration day 5	BYTE			hours	0 ... 72
nAd	d5_E03	49392	--	RW	Enable defrost weekdays or weekends day 5	BYTE			flag	0 ... 1
nAd	d6_E00	49377	--	RW	Enable functions during events day 6	BYTE			num	0 ... 8
nAd	d6_E01_h	49407	--	RW	Event start time (hours) day 6	BYTE			hours	0 ... 23
nAd	d6_E01_m	49406	--	RW	Event start time (minutes) day 6	BYTE			min	0 ... 59
nAd	d6_E02	49385	--	RW	Event duration day 6	BYTE			hours	0 ... 72
nAd	d6_E03	49393	--	RW	Enable defrost weekdays or weekends day 6	BYTE			flag	0 ... 1
nAd	d7_E00	49378	--	RW	Enable functions during events day 7	BYTE			num	0 ... 8
nAd	d7_E01_h	49409	--	RW	Event start time (hours) day 7	BYTE			hours	0 ... 23
nAd	d7_E01_m	49408	--	RW	Event start time (minutes) day 7	BYTE			min	0 ... 59
nAd	d7_E02	49386	--	RW	Event duration day 7	BYTE			hours	0 ... 72
nAd	d7_E03	49394	--	RW	Enable defrost weekdays or weekends day 7	BYTE			flag	0 ... 1
nAd	d8_E00	49379	--	RW	Enable functions during events day 8	BYTE			num	0 ... 8
nAd	d8_E01_h	49411	--	RW	Event start time (hours) day 8	BYTE			hours	0 ... 23
nAd	d8_E01_m	49410	--	RW	Event start time (minutes) day 8	BYTE			min	0 ... 59
nAd	d8_E02	49387	--	RW	Event duration day 8	BYTE			hours	0 ... 72
nAd	d8_E03	49395	--	RW	Enable defrost weekdays or weekends day 8	BYTE			flag	0 ... 1
Add	PtS	49289	49474.6	RW	Protocol selection (0: Televis; 1: ModBUS)	BYTE			flag	0/1
Add	dEA	49290	49475	RW	Device address, Micronet	BYTE			num	0...14
Add	FAA	49291	49475.2	RW	Family address, Micronet	BYTE			num	0...14
Add	Adr	49422	49453.6	RW	ModBUS address	BYTE			num	1...255
Add	Pty	49292	49475.4	RW	Parity bit (ModBUS protocol)	BYTE			num	0/1/2
Add	Pty	49293	49475.6	RW	ModBUS stop bit	BYTE			num	0/1
Add	bAU	49421	49454	RW	BaudRate	BYTE			num	0/1/2
diS	LOC	49294	49476	RW	Keypad lock	BYTE			flag	0/1
diS	PS1	16428	49476.2	RW	Password 1	WORD			num	0...999
diS	PS2	16430	49476.4	RW	Password 2	WORD			num	0...999
diS	PS3	16432	49476.6	RW	Password 3	WORD			num	0...999
diS	ndt	49295	49477	RW	Display with decimal point	BYTE			flag	0/1
diS	CA1	16434	49477.2	RW	Calibration Pb1	WORD	Y		°C/°F	-30.0...30.0



FOLDER	LABEL	PAR. Value ADDRESS	Vis. PAR. ADDRESS	R/W	DESCRIPTION	DATA SIZE	CPL	EXP	U.M.	RANGE
diS	CA2	16436	49477.4	RW	Calibration Pb2	WORD	Y		°C/°F	-30.0...30.0
diS	CA3	16438	49477.6	RW	Calibration Pb3	WORD	Y		°C/°F	-30.0...30.0
diS	CA	49296	49478	RW	Calibration operation	BYTE			num	0/1/2
diS	LdL	16440	49478.2	RW	Minimum possible value	WORD	Y		°C/°F	-58.0...HdL
diS	HdL	16442	49478.4	RW	Maximum possible value	WORD	Y		°C/°F	LdL...302
diS	ddL	49297	49478.6	RW	Lock display during defrost	BYTE			num	0/1/2
diS	Ldd	49298	49479	RW	Unlock timeout "ddl"	BYTE			minutes	0...255
diS	dro	49299	49479.2	RW	°C/°F selection. (0=°C, 1=°F)	BYTE			flag	0/1
diS	ddd	49300	49479.4	RW	Selection of main display value 1	BYTE			num	0/1/2
diS	dd2	49420	49491.2		Selection of main display value 2	BYTE			flag	0/1
HAC	SHi	16444	49479.6	RW	Maximum HACCP alarm threshold, no delay	WORD	Y	-1	°C/°F	SHH ... 150.0
HAC	SLi	16446	49480	RW	Minimum HACCP alarm threshold, no delay	WORD	Y	-1	°C/°F	-50.0 ... SLH
HAC	SHH	16448	49480.2	RW	Maximum HACCP alarm threshold	WORD	Y	-1	°C/°F	SLH ... 150.0
HAC	SLH	16450	49480.4	RW	Minimum HACCP alarm threshold	WORD	Y	-1	°C/°F	50.0 ... SHH
HAC	drA	49301	49480.6	RW	Minimum dwelling time in critical area before alarm signalling	BYTE			min	0 ... 99
HAC	drH	49302	49481	RW	HACCP alarm reset time from last manual reset	BYTE			hours	0 ... 255
HAC	H50	49303	49481.2	RW	Enable HACCP alarms storage with/without alarm relay enabling	BYTE			num	0/1/2
HAC	H51	49304	49481.4	RW	HACCP alarms storage disabling time (key or digital input)	BYTE			min	0 ... 255
HAC	H52	49305	49481.6	RW	Probe enabled to signal HACCP alarms	BYTE			flag	1/3
CnF	H00	49306	49482	RW	Probe type Pb1-Pb2-Pb3 (1=NTC, 0=PTC)	BYTE			flag	0/1
CnF	H01	49307	49482.2		Enable deep cooling	BYTE			flag	0/1
CnF	H02	49308	49482.4	RW	Key activation time	BYTE			sec	0 ... 15
CnF	H06	49309	49482.6	RW	Key or auxiliary digital input/light on with device Off	BYTE	Y		flag	0/1
CnF	H08	49310	49483	RW	Stand-by mode	BYTE			num	0 ... 3
CnF	H11	16452	49483.2	RW	DI1 input configuration	BYTE	Y		num	-20 ... 20
CnF	H12	16454	49483.4	RW	DI2 input configuration	BYTE	Y		num	-20 ... 20
CnF	H21	49311	49484.2	RW	Configuration relay 1	BYTE			num	0...13
CnF	H22	49312	49484.4	RW	Configuration relay 2	BYTE			num	0...13
CnF	H23	49313	49484.6	RW	Configuration relay 3	BYTE			num	0...13
CnF	H24	49314	49485	RW	Configuration relay 4	BYTE			num	0...13
CnF	H25	49315	49485.2	RW	Configuration relay 5	BYTE			num	0...13
CnF	H28	49318	49486	RW	Enable buzzer	BYTE			flag	0/1
CnF	H32	49320	49486.4	RW	Configuration of DOWN key	BYTE			num	0...15
CnF	H33	49321	49486.6	RW	ESC key configuration	BYTE			num	0...15
CnF	H34	49322	49487	RW	ON/OFF key configuration	BYTE			num	0...15
CnF	H35	49323	49487.2	RW	LIGHT key configuration	BYTE			num	0...15
CnF	H41	49327	49488.2	RW	Pb1 input configuration	WORD			flag	0/1
CnF	H42	49328	49488.4	RW	Pb2 input configuration	WORD			flag	0/1
CnF	H43	49329	49488.6	RW	Pb3 input configuration	WORD			flag	0/1
CnF	H48	49332	49489.4	RW	Clock presence	WORD			flag	0/1
CnF	H60	49333	49489.6	R	Preset selection (Vectors and parameters selection)	WORD			num	0...8
CnF	rEL	---	---	R	Device version	WORD			num	0...3
CnF	tAb	---	---	R	Map code	WORD			num	0...3
FrH	HOn	49336	49490.4	RW	Frame Heater regulator output On time	BYTE			min	0...255
FrH	HOF	49337	49490.6	RW	Frame Heater regulator output Off time	BYTE			min	0...255
FrH	dt3	49338	49491	RW	Frame Heater regulator time standard unit of measurement	BYTE			num	0/1/2
FPr	UL	--	--	--	Parameter transfer function visibility (Controller -> Copy Card)	2 BIT			num	0...3
FPr	dL	--	--	--	Parameter transfer function visibility (Copy Card -> Controller)	2 BIT			num	0...3
FPr	Fr	--	--	--	Copy Card formatting function visibility	2 BIT			num	0...3



9.3.8. PARAMETER/VISIBILITY H60 TABLE

LABEL	PAR. Value ADDRESS	Vis. PAR. ADDRESS	R/W	DESCRIPTION	DATA SIZE	U.M.	RANGE
V0-SEt	16752	--	RW	Regulation setpoint	WORD	°C/°F	LSE ... HSE
V0-diF	16754	--	RW	Setpoint differential	WORD	°C/°F	0.1 ... 30.0
V0-LSE	16756	--	RW	Minimum setpoint value that can be set	WORD	°C/°F	LSE ... HdL
V0-HSE	16758	--	RW	Maximum setpoint value that can be set	WORD	°C/°F	LdL ... HSE
V0-dSt	16760	--	RW	Defrost end temperature	WORD	°C/°F	-58.0 ... 302.0
V0-FSt	16762	--	RW	Evaporator fans status with Off compressor output	WORD	°C/°F	-50.0 ... 150.0
V0-dtY	49532	--	RW	Defrost mode	BYTE	num	0/1/2
V0-dit	49533	--	RW	Interval between defrost cycles	BYTE	min	0 ... 255
V0-dCt	49534	--	RW	Defrost interval count mode	BYTE	num	0 ... 3
V0-dOH	49535	--	RW	Defrost cycle activation delay from request	BYTE	min	0 ... 59
V0-dEt	49536	--	RW	Defrost timeout	BYTE	hours/ mins/secs	1 ... 255
V0-Fdt	49537	--	RW	Evaporator fans delay after defrost cycle	BYTE	min	0 ... 255
V0-dt	49538	--	RW	Dripping time	BYTE	min	0 ... 255
V0-dPO	49539	--	RW	Defrost enabling request from power-on	BYTE	flag	0/1
V0-ddL	49540	--	RW	Lock display during defrost mode	BYTE	num	0/1/2
V0-dFd	49541	--	RW	Evaporator fans disabling during defrost time	BYTE	flag	0/1
V1-SEt	16774	--	RW	Regulation setpoint	WORD	°C/°F	LSE ... HSE
V1-diF	16776	--	RW	Setpoint differential	WORD	°C/°F	0.1 ... 30.0
V1-LSE	16778	--	RW	Minimum setpoint value that can be set	WORD	°C/°F	LSE ... HdL
V1-HSE	16780	--	RW	Maximum setpoint value that can be set	WORD	°C/°F	LdL ... HSE
V1-dSt	16782	--	RW	Defrost end temperature	WORD	°C/°F	-58.0 ... 302.0
V1-FSt	16784	--	RW	Evaporator fans status with Off compressor output	WORD	°C/°F	-50.0 ... 150.0
V1-dtY	49554	--	RW	Defrost mode	BYTE	num	0/1/2
V1-dit	49555	--	RW	Interval between defrost cycles	BYTE	min	0 ... 255
V1-dCt	49556	--	RW	Defrost interval count mode	BYTE	num	0 ... 3
V1-dOH	49557	--	RW	Defrost cycle enabling delay from request	BYTE	min	0 ... 59
V1-dEt	49558	--	RW	Defrost timeout	BYTE	hours/ mins/secs	1 ... 255
V1-Fdt	49559	--	RW	Evaporator fans delay after defrost cycle	BYTE	min	0 ... 255
V1-dt	49560	--	RW	Dripping time	BYTE	min	0 ... 255
V1-dPO	49561	--	RW	Defrost enabling request from power-on	BYTE	flag	0/1
V1-ddL	49562	--	RW	Lock display during defrost mode	BYTE	num	0/1/2
V1-dFd	49563	--	RW	Evaporator fans disabling during defrost time	BYTE	flag	0/1
V2-SEt	16796	--	RW	Regulation setpoint	WORD	°C/°F	LSE ... HSE
V2-diF	16798	--	RW	Setpoint differential	WORD	°C/°F	0.1 ... 30.0
V2-LSE	16800	--	RW	Minimum setpoint value that can be set	WORD	°C/°F	LSE ... HdL
V2-HSE	16802	--	RW	Maximum setpoint value that can be set	WORD	°C/°F	LdL ... HSE
V2-dSt	16804	--	RW	Defrost end temperature	WORD	°C/°F	-58.0 ... 302.0
V2-FSt	16806	--	RW	Evaporator fans status with Off compressor output	WORD	°C/°F	-50.0 ... 150.0
V2-dtY	49576	--	RW	Defrost mode	BYTE	num	0/1/2
V2-dit	49577	--	RW	Interval between defrost cycles	BYTE	min	0 ... 255
V2-dCt	49578	--	RW	Defrost interval count mode	BYTE	num	0 ... 3
V2-dOH	49579	--	RW	Defrost cycle activation delay from request	BYTE	min	0 ... 59
V2-dEt	49580	--	RW	Defrost timeout	BYTE	hours/ mins/secs	1 ... 255
V2-Fdt	49581	--	RW	Evaporator fans delay after defrost cycle	BYTE	min	0 ... 255
V2-dt	49582	--	RW	Dripping time	BYTE	min	0 ... 255
V2-dPO	49583	--	RW	Defrost enabling request from power-on	BYTE	flag	0/1
V2-ddL	49584	--	RW	Lock display during defrost mode	BYTE	num	0/1/2
V2-dFd	49585	--	RW	Evaporator fans disabling during defrost time	BYTE	flag	0/1
V3-SEt	16818	--	RW	Regulation setpoint	WORD	°C/°F	LSE ... HSE
V3-diF	16820	--	RW	Setpoint differential	WORD	°C/°F	0.1 ... 30.0
V3-LSE	16822	--	RW	Minimum setpoint value that can be set	WORD	°C/°F	LSE ... HdL
V3-HSE	16824	--	RW	Maximum setpoint value that can be set	WORD	°C/°F	LdL ... HSE



V3-dSt	16826	--	RW	Defrost end temperature	WORD	°C/°F	-58.0 ... 302.0
V3-FSt	16828	--	RW	Evaporator fans status with Off compressor output	WORD	°C/°F	-50.0 ... 150.0
V3-dtY	49598	--	RW	Defrost mode	BYTE	num	0/1/2
V3-dit	49599	--	RW	Interval between defrost cycles	BYTE	min	0 ... 255
V3-dCt	49600	--	RW	Defrost interval count mode	BYTE	num	0 ... 3
V3-dOH	49601	--	RW	Defrost cycle activation delay from request	BYTE	min	0 ... 59
V3-dEt	49602	--	RW	Defrost timeout	BYTE	hours/ mins/secs	1 ... 255
V3-Fdt	49603	--	RW	Evaporator fans delay after defrost cycle	BYTE	min	0 ... 255
V3-dt	49604	--	RW	Dripping time	BYTE	min	0 ... 255
V3-dPO	49605	--	RW	Defrost enabling request from power-on	BYTE	flag	0/1
V3-ddL	49606	--	RW	Lock display during defrost mode	BYTE	num	0/1/2
V3-dFd	49607	--	RW	Evaporator fans disabling during defrost time	BYTE	flag	0/1
V4-SEt	16840	--	RW	Regulation setpoint	WORD	°C/°F	LSE ... HSE
V4-diF	16842	--	RW	Setpoint differential	WORD	°C/°F	0.1 ... 30.0
V4-LSE	16844	--	RW	Minimum setpoint value that can be set	WORD	°C/°F	LSE ... HdL
V4-HSE	16846	--	RW	Maximum setpoint value that can be set	WORD	°C/°F	LdL ... HSE
V4-dSt	16848	--	RW	Defrost end temperature	WORD	°C/°F	-58.0 ... 302.0
V4-FSt	16850	--	RW	Evaporator fans status with Off compressor output	WORD	°C/°F	-50.0 ... 150.0
V4-dtY	49620	--	RW	Defrost mode	BYTE	num	0/1/2
V4-dit	49621	--	RW	Interval between defrost cycles	BYTE	min	0 ... 255
V4-dCt	49622	--	RW	Defrost interval count mode	BYTE	num	0 ... 3
V4-dOH	49623	--	RW	Defrost cycle activation delay from request	BYTE	min	0 ... 59
V4-dEt	49624	--	RW	Defrost timeout	BYTE	hours/ mins/secs	1 ... 255
V4-Fdt	49625	--	RW	Evaporator fans delay after defrost cycle	BYTE	min	0 ... 255
V4-dt	49626	--	RW	Dripping time	BYTE	min	0 ... 255
V4-dPO	49627	--	RW	Defrost enabling request from power-on	BYTE	flag	0/1
V4-ddL	49628	--	RW	Lock display during defrost mode	BYTE	num	0/1/2
V4-dFd	49629	--	RW	Evaporator fans disabling during defrost time	BYTE	flag	0/1
V5-SEt	16862	--	RW	Regulation setpoint	WORD	°C/°F	LSE ... HSE
V5-diF	16864	--	RW	Setpoint differential	WORD	°C/°F	0.1 ... 30.0
V5-LSE	16866	--	RW	Minimum setpoint value that can be set	WORD	°C/°F	LSE ... HdL
V5-HSE	16868	--	RW	Maximum setpoint value that can be set	WORD	°C/°F	LdL ... HSE
V5-dSt	16870	--	RW	Defrost end temperature	WORD	°C/°F	-58.0 ... 302.0
V5-FSt	16872	--	RW	Evaporator fans status with Off compressor output	WORD	°C/°F	-50.0 ... 150.0
V5-dtY	49642	--	RW	Defrost mode	BYTE	num	0/1/2
V5-dit	49643	--	RW	Interval between defrost cycles	BYTE	min	0 ... 255
V5-dCt	49644	--	RW	Defrost interval count mode	BYTE	num	0 ... 3
V5-dOH	49645	--	RW	Defrost cycle enabling delay from request	BYTE	min	0 ... 59
V5-dEt	49646	--	RW	Defrost timeout	BYTE	hours/ mins/secs	1 ... 255
V5-Fdt	49647	--	RW	Evaporator fans delay after defrost cycle	BYTE	min	0 ... 255
V5-dt	49648	--	RW	Dripping time	BYTE	min	0 ... 255
V5-dPO	49649	--	RW	Defrost activation request from power-on	BYTE	flag	0/1
V5-ddL	49650	--	RW	Lock display during defrost mode	BYTE	num	0/1/2
V5-dFd	49651	--	RW	Evaporator fans disabling during defrost time	BYTE	flag	0/1



9.3.9. FOLDER VISIBILITY TABLE

LABEL	ModBUS ADDRESS	R/W	DESCRIPTION	DATA SIZE	RANGE	U.M.
vis_CPr	49450	RW	Display folder	2 bit	0 ... 3	num
vis_dEF	49450.2	RW	Display folder	2 bit	0 ... 3	num
vis_FAn	49450.6	RW	Display folder	2 bit	0 ... 3	num
vis_ALr	49451	RW	Display folder	2 bit	0 ... 3	num
vis_Lit	49451.2	RW	Display folder	2 bit	0 ... 3	num
vis_nAd	49450.4	RW	Display folder	2 bit	0 ... 3	num
vis_Add	49451.4	RW	Display folder	2 bit	0 ... 3	num
vis_diS	49451.6	RW	Display folder	2 bit	0 ... 3	num
vis_HAC	49452	RW	Display folder	2 bit	0 ... 3	num
vis_CnF	49452.2	RW	Display folder	2 bit	0 ... 3	num
vis_FrH	49452.4	RW	Display folder	2 bit	0 ... 3	num
vis_FPr	49452.6	RW	Display folder	2 bit	0 ... 3	num

9.3.10. CLIENT TABLE

NOTE: ModBUS read command: 03 (0x03) and ModBUS write command: 16 (0x10)

LABEL	ADDRESS	R/W	DESCRIPTION	DATA SIZE	RANGE	U.M.
AI1	337		Analogue input (display) 1	WORD	-58.0 ... 302.0	°C/°F
AI2	339		Analogue input (display) 2	WORD	-58.0 ... 302.0	°C/°F
AI3	341		Analogue input (display) 3	WORD	-58.0 ... 302.0	°C/°F
ValSondeReg[0]	345		Analogue input (regulation) 1	WORD	-58.0 ... 302.0	°C/°F
ValSondeReg[1]	347		Analogue input (regulation) 2	WORD	-58.0 ... 302.0	°C/°F
ValSondeReg[2]	349		Analogue input (regulation) 3	WORD	-58.0 ... 302.0	°C/°F
DI1	33130.4		Digital input 1	1 bit	0 ... 1	flag
DI2	33130.3		Digital input 2	1 bit	0 ... 1	flag
DI3	33130.2		Digital input 3	1 bit	0 ... 1	flag
DI4	33130.1		Digital input 4	1 bit	0 ... 1	flag
HA1	33085.5		Analogue input 1 high threshold exceeded	1 bit	0 ... 1	flag
LA1	33085.6		Analogue input 1 low threshold exceeded	1 bit	0 ... 1	flag
HA3	33085		Analogue input 3 high threshold exceeded	1 bit	0 ... 1	flag
LA3	33085.3		Analogue input 3 low threshold exceeded	1 bit	0 ... 1	flag
EAL	33085.4		External	1 bit	0 ... 1	flag
PA	33084.7		Pressure switch	1 bit	0 ... 1	flag
OPd	33085.7		Door open	1 bit	0 ... 1	flag
Pan	33084.1		Man in cold room alarm	1 bit	0 ... 1	flag
LPA	33084.2		Low pressure switch	1 bit	0 ... 1	flag
HPA	33084.3		High pressure switch	1 bit	0 ... 1	flag
E10	33084.6		Faulty clock alarm	1 bit	0 ... 1	flag
Ad2	33160		Defrost timeout	1 bit	0 ... 1	flag
Prr	33099.2		Preheat input regulator	1 bit	0 ... 1	flag
E1	33085.1		Analogue input 1 fault	1 bit	0 ... 1	flag
E2	33085.2		Analogue input 2 fault	1 bit	0 ... 1	flag
E3	33084.5		Analogue input 3 fault	1 bit	0 ... 1	flag
HACCP	33163.2		HACCP alarm	1 bit	0 ... 1	flag
OnOff	33089.1		Device status	1 bit	0 ... 1	flag
dEF_1	33092.4		Defrost 1	2 bit	0 ... 1	flag
dEF_2	33100.2		Defrost 2	2 bit	0 ... 1	flag
OSP	33089		Economy	1 bit	0 ... 1	flag
AUX	33089.4		Auxiliary	1 bit	0 ... 1	flag
FrameH	33101.6		Demisting heaters	1 bit	0 ... 1	flag
LIGHT	33089.2		Light	1 bit	0 ... 1	flag
Manutenzione (Maintenance)	33090.4		Maintenance	1 bit	0 ... 1	flag
COMP1	33092.3		Compressor 1	1 bit	0 ... 1	flag
COMP2	33099.4		Compressor 2	1 bit	0 ... 1	flag
FAN_EVAP	33094.7		Evaporator 1 fans	1 bit	0 ... 1	flag
FAN COND	33102.7		Condenser 1 fans	1 bit	0 ... 1	flag



LABEL	ADDRESS	R/W	DESCRIPTION	DATA SIZE	RANGE	U.M.
DOOR	33096.3		Door status	1 bit	0 ... 1	flag
Alarm	33097.5		Alarm status	1 bit	0 ... 1	flag
Deep Cooling	33102.5		Deep Cooling	1 bit	0 ... 1	flag
Pump Down	33102.4		Pump Down	1 bit	0 ... 1	flag
LIGHT_ON	33057		Lights on	1 bit	0 ... 1	num
LIGHT_OFF	33057.1		Lights off	1 bit	0 ... 1	num
OSP_ON	33057.2		Economy mode On	1 bit	0 ... 1	num
OSP_OFF	33057.3		Economy mode Off	1 bit	0 ... 1	num
AUX_ON	33057.4		Auxiliary output On	1 bit	0 ... 1	num
AUX_OFF	33057.5		Auxiliary output Off	1 bit	0 ... 1	num
ON	33057.6		Instrument on	1 bit	0 ... 1	num
OFF	33057.7		Instrument off	1 bit	0 ... 1	num
SILENT	33058		Alarm acknowledgement	1 bit	0 ... 1	num
DEF	33058.1		Manual defrost activation	1 bit	0 ... 1	num
NIGHTDAY_OFF	33058.5		Disable Night & Day function	1 bit	0 ... 1	num
NIGHTDAY_ON	33058.6		Enable Night & Day function	1 bit	0 ... 1	num
LOCK_KBD	33059		Keypad lock	1 bit	0 ... 1	num
UNLOCK_KBD	33059.1		Unlock keypad	1 bit	0 ... 1	num
RST_HACCP	33059.2		Reset HACCP alarms	1 bit	0 ... 1	num
RST_PRESS	33059.3		Reset Pressure switch alarms	1 bit	0 ... 1	num
FRAMEHEATER_ON	33059.4		Frame Heater regulator activation	1 bit	0 ... 1	num
FRAMEHEATER_OFF	33059.5		Frame Heater regulator deactivation	1 bit	0 ... 1	num
HACCP_OFF	33059.6		Disable HACCP alarm recording	1 bit	0 ... 1	num
HACCP_ON	33059.7		Enable HACCP alarm recording	1 bit	0 ... 1	num
DEEP_COOL	33060		Deep Cooling regulator activation	1 bit	0 ... 1	num

10. ADVANCED FUNCTIONS - NIGHT AND DAY



Events and cycles can be programmed at set times during the week using the Night&Day regulator algorithm. The parameters concerned are contained in folder **nAd** / sub-folder **d0...d6, Ed**.

IMPORTANT: do not confuse labels **E0 ... E3** with probe error messages **E1 ... E2**.

IMPORTANT: be careful as to how **E0 = 3** (stand-by regulator) is used. You may not have access to the device for the duration of the event set in **E2**.

10.1. DAY/NIGHT REGULATOR OPERATION

Different events for days of the week.

For each day of the week, indicated by parameters/(sub-folders) **d0 ... d6**, you can set:

- a time for the start of the event (**E1, in the format HH:mm**)
- the duration (**E2**)
- which functions to enable (**E0**) for the event
- which defrost group to enable (**dE1..dE8 weekdays** or **F1...F8 weekends/public holidays**) (**E3**).

Parameters **E0 ... E3** can be different for each day.

According to the time set, E1 is the start time, usually set for the Reduced set (Economy) function ("NIGHT" mode). The duration is determined by parameter E2. In this mode, parameter E0 allows you to:

- Activate the reduced set functions.
- Activate the light regulator.
- Activate the aux regulator.
- Activate the stand-by regulator.

You can also decide whether to enable defrost during weekdays (E3 = 0) and weekends/public holidays (E3 = 1).

ATTENZIONE: bear in mind that parameter **E3** has no effect on the daily event settings.

Daily event

Using the same parameters, E0 ... E3 in the (sub-)folder Ed, you can also program a daily event, i.e. one that runs every day. Defrosts cannot be managed with this function. Hence parameter E3 in (sub-) folder d7 is not listed.

Daily or weekly events all have the same priority.

Days of the week correspond to these parameters:

Meaning of LEDs:

Par.	Day	
d0	Sunday	
d1	Monday	
d2	Tuesday	
d3	Wednesday	
d4	Thursday	
d5	Friday	
d6	Saturday	
d7	Daily event (Every Day)	



10.2. OPERATION WITH DEFROST GROUP

If E0 is not equal to 0, the meaning of weekday parameters dE1...dE8 shifts from:

Defrost group valid EVERY day (see Automatic defrost with Real Time Clock)

to:

Defrost group applicable only to weekdays.

The weekday parameters dE1...dE8 are supplemented with the management of weekend/public holiday parameters F1...F8.

Both folders still make use of the conditions for defrost at a pre-established time.

Hence for each day d0...d6 we can determine whether:

- E3 = 0, so that defrosts run at the times set in dE1...dE8.
- E3 = 1, so that defrosts run at the times set in F1...F8.

Example.

Supposing you set these time configurations:

- 3 "weekend" defrosts (when the chiller cabinet is not being intensively used)
 - 2 am (F1=> h02 '00)
 - 10 am (F2=> h10 '00)
 - 6 pm (F3=> h18 '00)
- 4 defrosts on "weekdays" (or days when the chiller cabinet is used intensively)
 - 5 am (dE1=> h05 '00)
 - 11 am (dE2=> h11 '00)
 - 5 pm (dE3=> h17 '00)
 - 11 pm (dE4=> h23 '00)

if the days considered as weekends/holidays are Sunday and Monday, this means the day settings will be:

- d0 / E3 = 1 (Sunday = "weekend" day)
- d1 / E3 = 1 (Monday = "weekend" day)
- d2 / E3 = 0 (Tuesday = "weekday")
- d3 / E3 = 0 (Wednesday = "weekday")
- d4 / E3 = 0 (Thursday = "weekday")
- d5 / E3 = 0 (Friday = "weekday")
- d6 / E3 = 0 (Saturday = "weekday")

10.3. DAY/NIGHT REGULATOR DURING A BLACKOUT

- If a blackout occurs during the activation period of a day/night status (i.e. caused by a day/night event), and power is restored:
 - During this event, the instrument will return to the status implemented at the time of the blackout, before disabling the event at the programmed time.
 - If it occurs after this event but before the next day/night event, the device starts up as if it has disabled the day/night event during which the blackout occurred.
 - If it occurs after this event but during the next day/night event, the device starts up as if it has disabled the day/night event during which the blackout occurred, before switching to the status requested by the day/night event underway when power was restored.
- Manual events (key or digital input) have priority over the day/night status until the next day/night event (event that either disables the current status or activates the next one) if the power supply is uninterrupted.
- If a manual event inverts the status set by the day/night function within the day/night status activation period and this is followed by a blackout, and power is restored:
 - During the activation period of the same day/night status, the controller will return to the status set by the manual event before disabling the event at the programmed time.
 - If it occurs after this event, the device starts in the status set by the manual event.
 - If it occurs after this event but during the activation period of the next day/night event, the controller switches to the status requested by the day/night event concerned before disabling the event at the programmed time.



10.4. OPENING FOLDER NAD - DAY/NIGHT

Display	Description
	Press SET for 3 seconds
	Folder USr appears Use the UP & DOWN keys to search for the InS folder Press and release the SET key
	Use the UP & DOWN keys to search for the nAd folder
	Press and release the SET key Press and release the SET key to open the folder
	The first day, d0, appears Scroll using 'UP' and 'DOWN' to access the other days d1...d6 and Every Day d7 Press and release the SET key
	The first parameter E0 appears Press and release the SET key to modify it The E0 label will blink Use the UP & DOWN keys to adjust its value
	The first parameter E0 appears Press and release the SET key to modify it The E0 label will blink Use the UP & DOWN keys to adjust its value
	Press the ESC key several times to return to the normal display, or repeat the procedure to modify another parameter NOTE: in the case of parameter E1, the clock LED will switch on. Modification takes place in the same way as the time setting procedure (see User Interface)

11. ADVANCED FUNCTIONS - HACCP



To meet the minimum requirements prescribed in HACCP regulations, there is a set of dedicated parameters. These parameters can be viewed and configured in folder:

HACCP (folder with label "HAC")

The recording of HACCP alarms can be enabled in parameter H50≠0.

IMPORTANT! SWITCH THE INSTRUMENT OFF AND ON AGAIN AFTER MODIFYING PARAMETER H50.

HACCP alarm START and storing begins every time the alarms are cleared - see paragraph Deleting HACCP alarms.

These parameters record and file the high and low temperature alarms for cold room probe Pb1 or display probe Pb3, as well as any instrument power failures.

In addition to alarms, these parameters also record any controller blackouts, saving the number of blackouts that have occurred since the last time the machine was stopped.

Alarms for the HACCP function are managed independently from the rest of the regulators.

Each HACCP alarm consists of a folder containing the following information:

- alarm number: up to 40 alarms can be saved: 20 for high/low temperature and 20 for power failure
- type of alarm: Ht (high temperature), Lt (low temperature) and PF (Power failure)
- time/date and duration of all alarms
- maximum or minimum temperature, with corresponding time/date, reached during the event.

SLi, SHi parameters Instant HACCP alarm

When a temperature value exceeds the range defined by parameters SLi and SHi, an HACCP alarm is signalled and recorded.









This threshold indicates the limit beyond which the food concerned would deteriorate irreparably, even for brief periods of time.

SLL, SHH parameters HACCP alarm

When a temperature value exceeds the range defined by parameters SLL and SHH for a time greater than the drA parameter, a HACCP alarm is signalled and displayed.



11.1. DISPLAYING HACCP ALARMS

Display	Description
	<p>The red HACCP LED will remain permanently on to indicate an HACCP alarm has occurred Press and release the UP key</p> <p>The upper display will show ALr If HACCP alarms have occurred the lower display will show HACCP Press and release the SET key</p>
	<p>To access the information contained within each AHC folder, press the 'set' key</p>
	<p>The clock LED will be permanently on</p> <p>In fact, label StA will be shown on the upper display, while the alarm start time will appear on the lower display</p> <p>Use the DOWN key to scroll through the other alarm data</p>
	<p>The date LED will be permanently on</p> <p>In fact, label StA will be shown on the upper display, while the alarm activation date will appear on the lower display</p> <p>Use the DOWN key to scroll through the other alarm data</p>
	<p>Label dur will be shown on the upper display, while the alarm duration will appear on the lower display In HH:mm If --.-- appears, the alarm is still active</p> <p>Use the DOWN key to scroll through the other alarm data</p>
	<p>The clock LED will be permanently on</p> <p>...and the maximum temperature measured by the probe during the alarm (on the upper display) will be displayed along with the relative date (lower display) Use the DOWN key to scroll through the other alarm data</p>
	<p>The clock LED will be permanently on</p> <p>...and the maximum temperature measured by the probe during the alarm (on the upper display) will be displayed along with the relative date (lower display) Use the DOWN key to scroll through the other alarm data</p>
	<p>To return to the alarm display screen (label AHC) press the ESC key once</p> <p>Press the ESC key several times to return to the normal display</p>

Eliwell Controls s.r.l.

Via dell'Industria, 15 • Z.I. Paludi
32010 Pieve d'Alpago (BL) ITALY
T +39 0437 986 111

www.eliwell.com

Technical Customer Support:

T +39 0437 986 300
E techsuppeliwell@schneider-electric.com

Sales

T +39 0437 986 100 (Italy)
T +39 0437 986 200 (other countries)
E saleseliwell@schneider-electric.com

